

Our Map

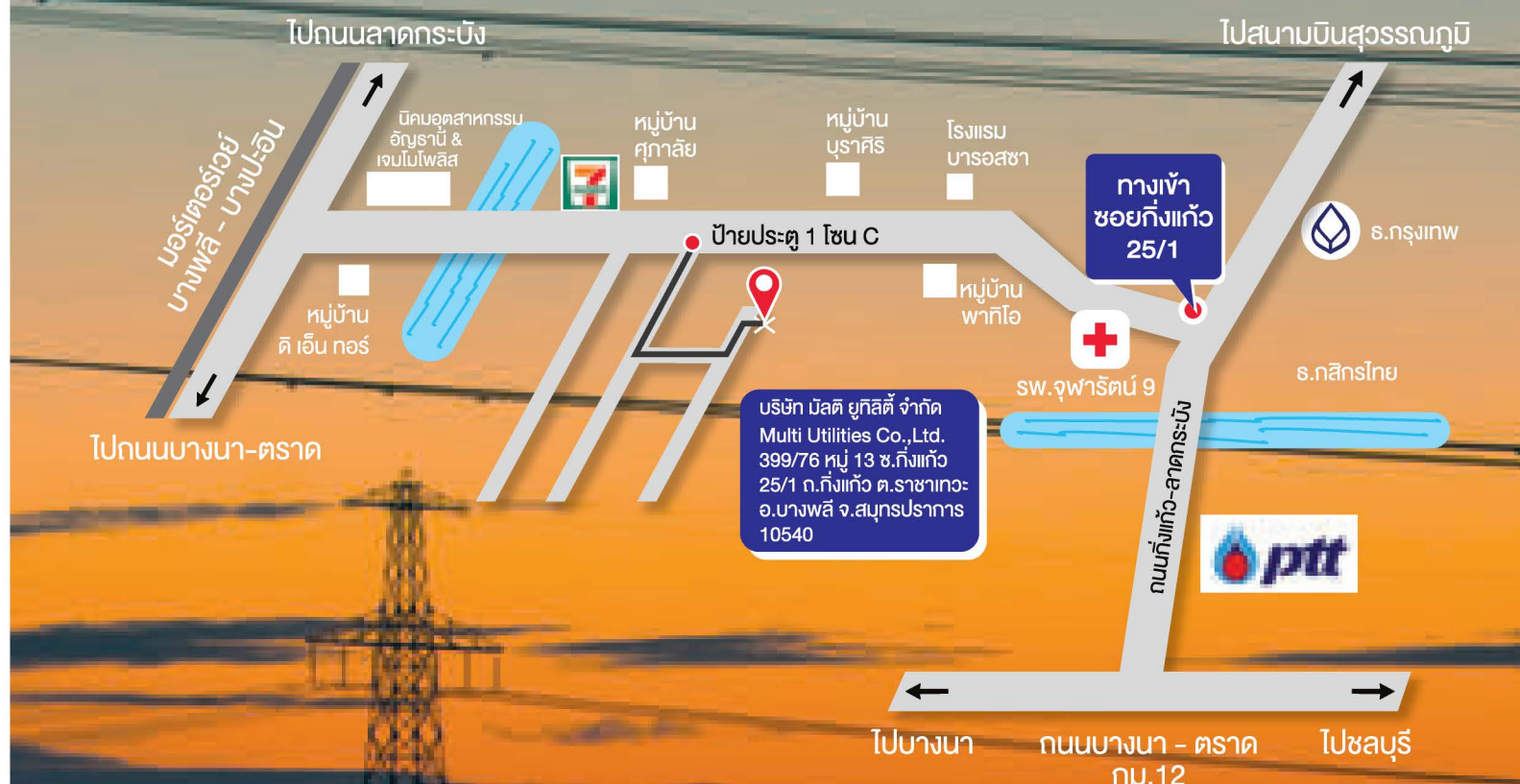

Multi Utilities Co.,Ltd.

บริษัท มัลติ ยูทิลิตี้ จำกัด

399/76 หมู่ 13 ซ.กิ่งแก้ว 25/1 ถ.กิ่งแก้ว

ต.ราชาเทวะ อ.บางพลี จ.สมุทรปราการ 10540

Tel : +66 2 136 1800-8 Fax +66 2 136 1809

E-mail : support@multi.co.th

www.multi.co.th

 multi.utilities
  @multiutilities
  multi_utilities

Copyright 2011 Multi Utilities Co.,Ltd. All right reserved



MULTI UTILITIES CO.,LTD.

“Your Electrical System Solution”

Power of Brand

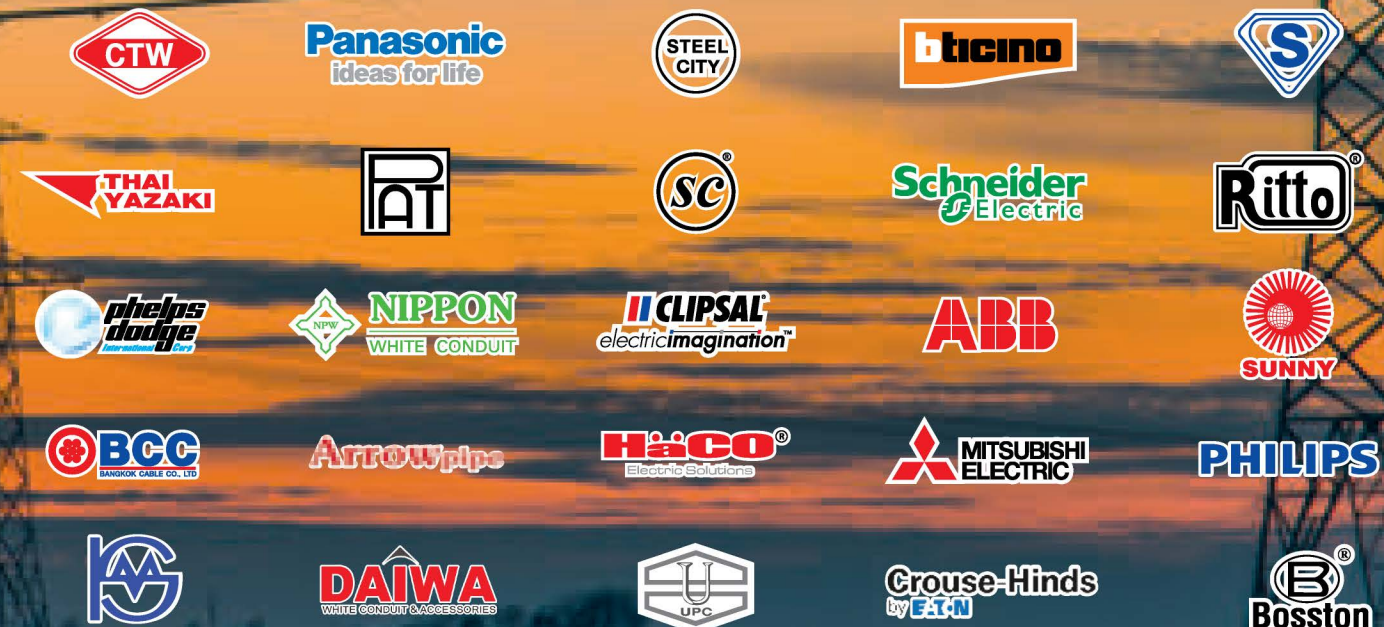

ELECTRICAL CABLES AND ACCESSORIES

- ◆ Electric Wire And Cables ◆ Compact Enclosures ◆ Steel Conduits
- ◆ Emergency Light & Light ◆ Tranformer ◆ Steel & Conduits Accessories
- ◆ UPVC Conduits ◆ Switches and Receptacles ◆ Circuit & Watt Hour Meters
- ◆ Grounding & Lightning Protection System ◆ Termination Kit & Eplosion Proof

ML MULTI UTILITIES CONTENT

<p>สายไฟ Electric Wires & Cables</p>	 	 	<p>3</p>
<p>ตู้ไซท์ และ ราง COMPACT ENCLOSURES</p>	  	 	<p>18</p>
<p>ท่อร้อยสายไฟ Steel Conduits</p>	 	  	<p>40</p>
<p>อุปกรณ์ท่อและสาย Steel & Conduit Accessories</p>			<p>42</p>
<p>ท่อร้อยสายไฟยูพีวีซี uPVC Conduits</p>			<p>47</p>
<p>สวิตช์และเต้ารับไฟฟ้า Switches and Receptacles</p>	 	 	<p>48</p>
<p>เซอร์กิตเบรกเกอร์ และมิเตอร์ Circuit Breakers and Watt Hour Meters</p>	 		<p>50</p>
<p>ไฟฉุกเฉิน และ โคมไฟ EMERGENCY LIGHT & LIGHT</p>			<p>52</p>
<p>ระบบสายดิน ระบบป้องกันฟ้าผ่า ผลิตภัณฑ์ กลุ่มไฟฟ้าแรงสูง และอุปกรณ์กันระเบิด Grounding & Lightning Protection System Termination Kit & Explosion Proof</p>	 	 	<p>66</p>

MULTI
UTILITIES

CHAROONG THAI



THAI YAZAKI



PHELPS DODGE



BANGKOK CABLE



THW

450/750 V 70° C
60227 IEC 01
TIS 11-2553



Number of Cores จำนวนแกน	Cross Sectional Area (sq.mm) ขนาดพื้นที่หน้าตัด (ตร.มม.)	Price (Baht / Meter) ราคา (บาท / เมตร)
1	1.5	8.20
1	2.5	12.10
1	4	18.70
1	6	30.00
1	10	49.30
1	16	76.50
1	25	120.00
1	35	170.50
1	50	229.20
1	70	327.70
1	95	451.50
1	120	572.00
1	150	700.00
1	185	879.00
1	240	1,153.00
1	300	1,445.00
1	400	1,850.00

**หมายเหตุ

- ต่อนำขนาด 1.5 - 4 ตร.มม. เป็นลวด Solid
- ต่อนำขนาด 6 - 400 ตร.มม. เป็นลวด Strand

NYY

450/750 V 70° C
TIS 11-2559 (1-4 CORES)



Cross Sectional Area (sq.mm) ขนาดพื้นที่หน้าตัด (ตร.มม.)	Price (Baht / Meter), ราคา (บาท / เมตร)			
	1 Core	2 Cores	3 Cores	4 Cores
1	22.50	45.09	51.03	58.10
1.5	25.00	50.46	57.59	66.40
2.5	29.20	60.31	70.57	82.50
4	39.40	85.33	101.51	122.08
6	58.80	117.98	146.30	178.17
10	70.50	166.35	213.41	270.87
16	98.80	233.66	310.93	405.25
25	144.60	342.91	474.36	608.70
35	196.00	454.33	640.97	884.77
50	259.70	630.30	874.70	1,115.00
70	352.80	891.00	1,183.70	1,550.00
95	474.00	1,200.00	1,656.90	2,155.00
120	608.00	1,490.00	2,092.00	2,726.00
150	746.00	1,830.00	2,546.00	3,338.00
185	928.00	2,288.00	3,170.00	4,189.00
240	1,209.00	2,992.00	4,145.00	5,519.00
300	1,507.00	3,724.00	5,136.00	6,850.00
400	1,928.00	-	-	-
500	2,527.00	-	-	-

**หมายเหตุ • ตัวยานขนาด 1 - 4 ตร.มม. เป็นลวด Solid • ตัวยานขนาด 6 - 500 ตร.มม. เป็นลวด Strand

NYY-G

450/750 V 70° C
TIS 11-2559 (2-4 CORES WITH GROUND)

Cross Sectional Area (sq.mm) ขนาดพื้นที่หน้าตัด (ตร.มม.)	Price (Baht / Meter), ราคา (บาท / เมตร)		
	2 Cores	3 Cores	4 Cores
1/1	51.03	58.10	82.56
1.5/1.5	57.59	66.40	93.32
2.5/2.5	70.57	82.50	128.88
4/4	101.51	122.08	190.29
6/6	146.30	178.17	277.89
10/10	213.41	270.87	423.39
16/16	328.25	425.25	645.65
25/16	450.74	574.00	890.90
35/16	607.03	840.15	1,284.00
50/25	873.98	1,095.00	1,655.00
70/35	1,151.62	1,530.78	2,290.00
95/50	1,600.06	2,109.53	3,155.00
120/70	2,013.00	2,688.11	3,935.00
150/95	2,486.14	3,277.72	4,840.00
185/95	3,034.00	4,097.51	6,015.00
240/120	3,946.00	5,401.11	7,850.00
300/150	4,927.94	6,689.92	9,785.00

**หมายเหตุ • ตัวยกขนาด 1/1 - 4/4 ตร.มม. เป็นลวด Solid • ตัวยกขนาด 6/6 - 300/150 ตร.มม. เป็นลวด Strand

VCT

450/750 V 70° C
TIS 11-2559 (2-4 CORES)



Cross Sectional Area (sq.mm) ขนาดพื้นที่หน้าตัด (ตร.มม.)	Price (Baht / Meter), ราคา (บาท / เมตร)		
	2 Cores	3 Cores	4 Cores
1	27.04	36.67	45.69
1.5	35.74	45.35	58.67
2.5	57.45	81.90	91.49
4	79.50	100.40	127.50
6	112.90	146.90	191.20
10	195.30	256.30	335.50
16	280.00	379.00	485.40
25	441.50	571.00	731.40
35	585.10	798.00	1,018.00

VCT-G

450/750 V 70° C

TIS 11-2559 (2-4 CORES WITH GROUND)



Cross Sectional Area (sq.mm) ขนาดพื้นที่หน้าตัด (ตร.มม.)	Price (Baht / Meter), ราคา (บาท / เมตร)		
	2 Cores	3 Cores	4 Cores
1/1	36.67	45.69	66.80
1.5/1.5	45.35	58.67	82.87
2.5/2.5	81.90	91.49	120.76
4/4	100.40	127.50	176.94
6/6	146.90	191.20	300.45
10/10	256.30	335.50	455.00
16/16	379.00	485.40	645.00
25/16	555.12	720.58	940.00
35/16	770.33	992.71	1,315.00

600 V CVV



600 V CVV (2-30 CORES)

Number of Cores จำนวนแกน	Price (Baht / Meter), ราคา (บาท / เมตร)				
	Cross Sectional Area (sq.mm) ขนาดพื้นที่หน้าตัด (ตร.มม.)				
	0.75 sq.mm	1 sq.mm	1.5 sq.mm	2.5 sq.mm	4 sq.mm
2	34.30	36.50	40.30	54.50	74.80
3	38.10	41.90	49.30	68.80	94.30
4	47.80	49.40	59.80	85.30	125.60
5	58.30	65.00	76.20	109.20	152.50
7	68.80	78.50	94.30	137.80	198.90
9	91.30	106.20	129.40	183.80	263.20
10	98.70	114.40	140.40	201.80	290.00
12	109.90	128.60	158.50	233.20	342.20
14	121.80	140.50	176.40	261.60	386.10
16	130.80	153.90	195.00	292.50	445.90
19	148.70	175.80	224.50	341.90	517.40
21	167.70	198.90	250.90	379.60	572.00
24	185.90	219.70	280.80	439.40	647.40
27	206.70	239.20	312.40	484.40	722.20
30	221.00	261.30	341.90	531.70	795.60

600 V CVV-S

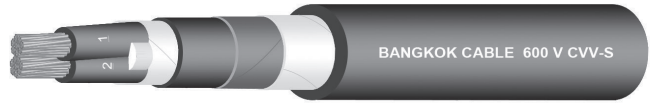
600 V CVV-S (2-30 CORES)

Number of Cores จำนวนแกน	Price (Baht / Meter), ราคา (บาท / เมตร)				
	Cross Sectional Area (sq.mm) ขนาดพื้นที่หน้าตัด (ตร.มม.)				
	0.75 sq.mm	1 sq.mm	1.5 sq.mm	2.5 sq.mm	4 sq.mm
2	62.80	65.65	73.20	91.30	121.20
3	68.80	74.80	83.70	109.00	145.60
4	80.60	85.30	98.80	130.00	176.40
5	94.30	101.70	116.60	158.60	209.30
7	109.20	119.60	141.70	191.10	262.60
9	133.90	147.90	171.60	239.20	326.30
10	146.90	159.90	187.20	261.30	366.60
12	158.60	174.20	209.30	291.20	406.90
14	174.20	195.00	230.10	322.40	475.80
16	187.20	211.90	254.80	361.40	533.00
19	209.30	239.20	283.40	416.00	598.00
21	228.80	258.70	309.40	470.60	676.00
24	254.80	289.90	349.70	530.40	773.50
27	278.20	313.30	383.50	581.10	847.60
30	295.10	339.30	425.10	633.10	926.90

0.6/1 KV CV



0.6/1 KV CV XLPE/PVC
IEC 60502-1 (1-4 CORES)

Cross Sectional Area (sq.mm) ขนาดพื้นที่หน้าตัด (ตร.มม.)	Price (Baht / Meter), ราคา (บาท / เมตร)			
	1 Core	2 Cores	3 Cores	4 Cores
2.5	24.95	56.50	70.65	87.20
4	31.45	71.50	92.00	114.70
6	41.30	93.80	122.00	153.00
10	54.50	120.00	165.00	224.00
16	81.00	185.00	252.00	330.00
25	123.50	295.00	400.00	523.00
35	170.00	397.00	540.00	707.00
50	234.50	530.00	728.00	965.00
70	329.00	736.00	1,029.00	1,360.00
95	453.00	1,012.00	1,405.00	1,870.00
120	575.00	1,277.00	1,790.00	2,380.00
150	704.00	1,566.00	2,200.00	2,930.00
185	882.00	1,952.00	2,770.00	3,700.00
240	1,156.00	2,555.00	3,620.00	4,850.00
300	1,460.00	3,193.00	4,520.00	6,310.00
400	1,870.00	4,068.00	5,900.00	7,970.00
500	2,500.00	-	-	-
630	3,200.00	-	-	-
800	4,005.00	-	-	-
1,000	5,285.00	-	-	-

0.6/1 KV FR-CV



**0.6/1 KV XLPE/FR-PVC
IEC 60502-1 (1-4 CORES)**

Cross Sectional Area (sq.mm) ขนาดพื้นที่หน้าตัด (ตร.มม.)	Price (Baht / Meter), ราคา (บาท / เมตร)			
	1 Core	2 Cores	3 Cores	4 Cores
2.5	26.29	59.54	74.45	91.89
4	33.18	75.42	97.05	120.99
6	43.47	98.74	128.42	161.05
10	57.43	126.45	173.87	236.04
16	85.53	195.35	266.10	348.47
25	127.19	303.81	411.95	538.62
35	175.62	410.12	557.85	730.37
50	242.00	546.96	751.29	995.87
70	339.18	758.76	1,060.82	1,402.06
95	467.98	1,045.45	1,451.45	1,931.82
120	593.40	1,317.85	1,847.27	2,456.14
150	727.27	1,617.77	2,272.73	3,026.86
185	908.34	2,010.30	2,852.73	3,810.50
240	1,189.30	2,628.60	3,724.28	4,989.71
300	1,506.71	3,295.15	4,664.60	6,511.87
400	1,927.84	4,193.81	6,082.47	8,216.49
500	2,574.67	-	-	-
630	3,292.18	-	-	-
800	4,128.87	-	-	-
1,000	5,442.84	-	-	-

1.8/3 (3.6) KV CV
3.6/6 (7.2) KV CV
6/10 (12) KV CV

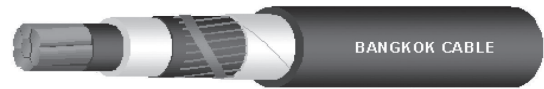

(1 CORE)



(3 CORES)

XLPE/PVC
POWER CABLE (CV)
IEC 60502-2

Cross Sectional Area (sq.mm) ขนาดพื้นที่หน้าตัด (ตร.มม.)	Price (Baht / Meter), ราคา (บาท / เมตร)					
	1.8/3 (3.6) KV		3.6/6 (7.2) KV		6/10 (12) KV	
	1 Core	3 Cores	1 Core	3 Cores	1 Core	3 Cores
10	126.70	336.60	159.00	498.00	-	-
16	161.00	443.50	198.00	608.00	246.00	762.00
25	210.00	592.70	245.00	766.00	296.00	929.00
35	257.40	740.50	299.00	927.00	351.00	1,102.00
50	320.80	955.70	365.00	1,156.00	423.00	1,334.00
70	425.00	1,268.00	465.00	1,468.00	528.00	1,676.00
95	553.00	1,669.00	591.00	1,873.00	659.00	2,102.00
120	686.00	2,075.00	718.00	2,276.00	789.00	2,501.00
150	826.00	2,514.00	866.00	2,685.00	927.00	2,915.00
185	1,012.00	3,094.00	1,057.00	3,218.00	1,119.00	3,545.00
240	1,298.00	3,970.00	1,359.00	4,118.00	1,428.70	4,503.00
300	1,598.00	4,904.00	1,672.00	5,060.00	1,747.00	5,490.00
400	2,004.00	6,152.00	2,097.00	6,466.00	2,187.00	6,847.00
500	2,535.00	-	2,653.00	-	-	-

8.7/15 (17.5) KV CV

12/20 (24) KV CV

18/30 (36) KV CV

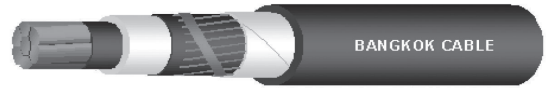
(1 CORE)

(3 CORES)

XLPE/PVC
POWER CABLE (CV)
 IEC 60502-2

Cross Sectional Area (sq.mm) ขนาดพื้นที่หน้าตัด (ตร.มม.)	Price (Baht / Meter), ราคา (บาท / เมตร)					
	8.7/15 (17.5) KV		12/20 (24) KV		18/30 (36) KV	
	1 Core	3 Cores	1 Core	3 Cores	1 Core	3 Cores
25	338.00	1,079.00	-	-	-	-
35	397.00	1,258.00	438.00	1,408.00	602.00	1,981.00
50	467.00	1,512.00	515.00	1,652.00	633.00	2,097.00
70	577.00	1,847.00	620.00	1,996.00	746.00	2,504.00
95	711.00	2,271.00	757.00	2,474.00	889.00	2,952.00
120	844.00	2,795.00	896.00	2,898.00	1,026.00	3,410.00
150	977.00	3,166.00	1,028.00	3,331.00	1,174.00	3,856.00
185	1,164.00	3,715.00	1,209.00	3,938.00	1,362.00	4,438.00
240	1,478.00	4,649.00	1,515.00	5,051.00	1,656.00	5,573.00
300	1,797.00	5,747.00	1,843.00	5,957.00	1,953.00	6,648.00
400	2,241.00	7,000.00	2,287.00	7,224.00	2,410.00	7,961.00

THW-A



THW-A 750 V 70°C
TIS 293-2541 TABLE 1

Number of Cores จำนวนแกน	Cross Sectional Area (sq.mm) ขนาดพื้นที่หน้าตัด (ตร.มม.)	Price (Baht / Meter) ราคา (บาท / เมตร)
1	10	9.08
1	16	12.32
1	25	18.17
1	35	23.48
1	50	31.64
1	70	49.66
1	95	64.88
1	120	79.33
1	150	96.46
1	185	120.06
1	240	157.03
1	300	192.08



CABLE TYPE : CTW-SAC 25 kV

25 kV ALUMINUM STRANDED CONDUCTOR CROSS-LINKED POLYETHYLENE INSULATED AND SHEATHED SPACED AERIAL CABLE

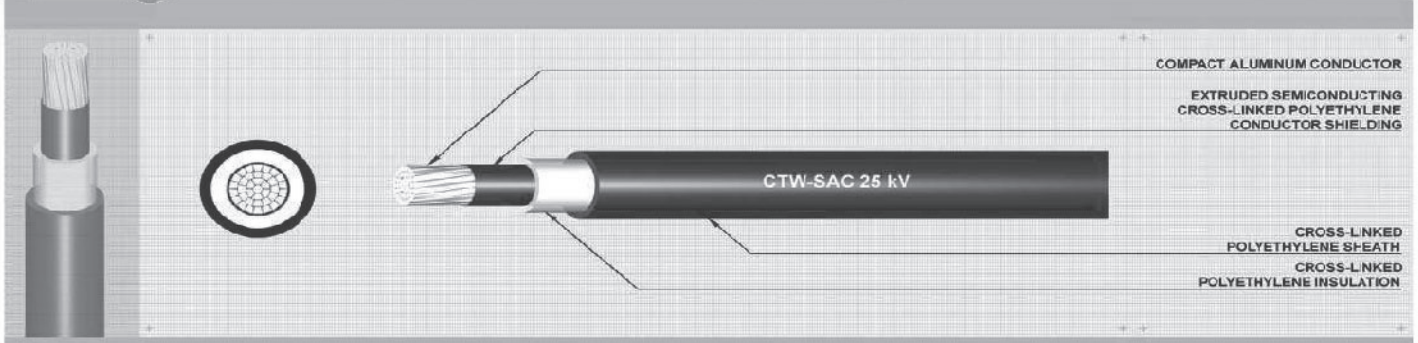

CABLE TYPE : CTW-SAC 35 kV

35 kV ALUMINUM STRANDED CONDUCTOR CROSS-LINKED POLYETHYLENE INSULATED AND SHEATHED SPACED AERIAL CABLE

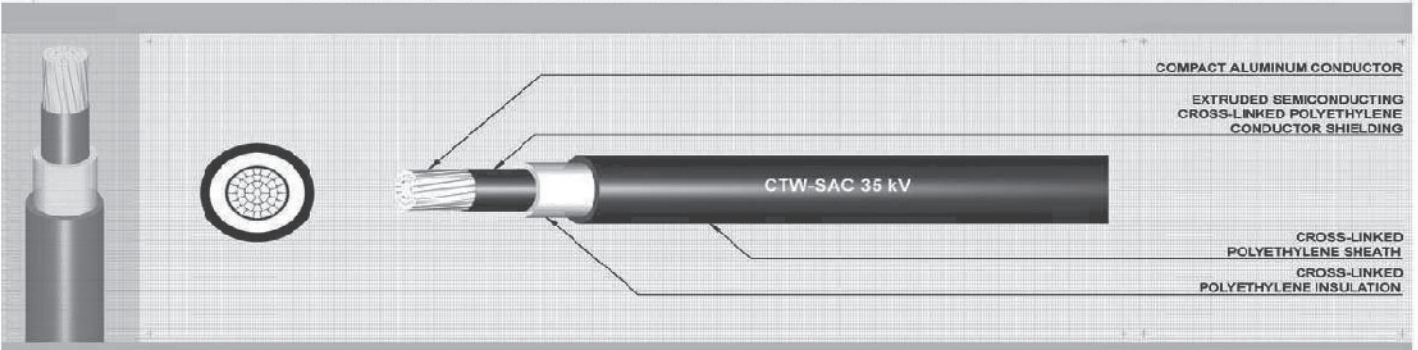

CROSS-LINKED POLYETHYLENE INSULATED AND SHEATHED SPACED AERIAL CABLE

CROSS SECTIONAL AREA(SQ.MM.) ขนาด พื้นที่หน้าตัด(ตร.มม.)	Price(Baht/Meter) ราคา(บาท/เมตร)	
	CTW-SAC 25 KV	CTW-SAC 35 KV
35	130.00	140.50
50	136.25	163.25
70	179.75	185.63
95	201.63	205.75
120	237.75	241.00
185	274.75	302.63
240	333.88	366.00



CABLE TYPE : **CTW-FRC - SL 600 S**
SINGLE-CORE COPPER XLPO INSULATED NON-SHEATHED

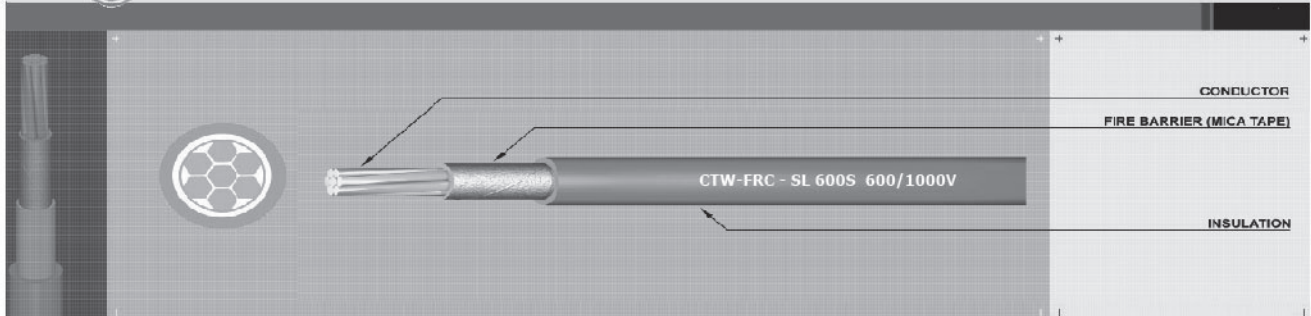

CABLE TYPE : **CTW-FLC/LSHF - SL 600 S**
SINGLE-CORE COPPER CONDUCTOR CROSS-LINKED INSULATED NON-SHEATHED

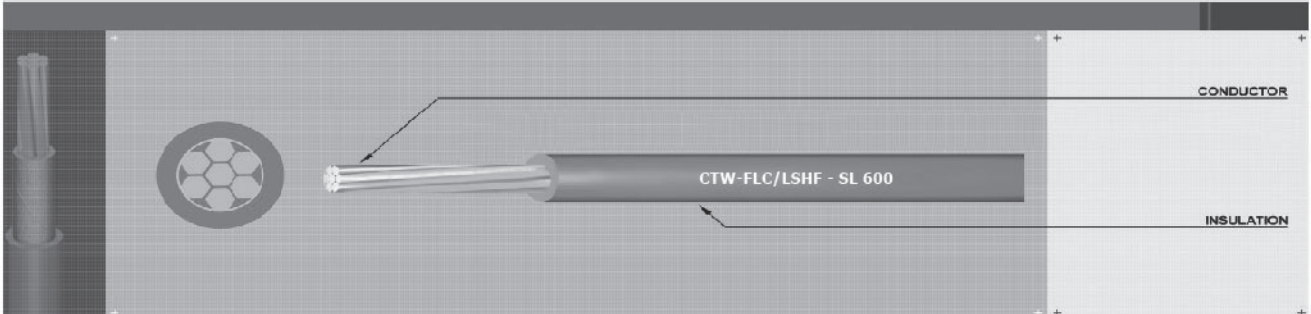

FIRE RESISTANT CABLES สายทนไฟ

CROSS SECTIONAL AREA(SQ.MM.) ขนาดพื้นที่หน้าตัด (ตร.มม.)	Price(Baht/Meter) ราคา(บาท/เมตร)	
	FRC - SL 600 S	FLC/LSHF - SL 600 S
1.5	41.00	41.00
2.5	48.00	48.00
4	62.00	62.00
6	81.00	81.00
10	112.00	112.00
16	152.00	152.00
25	218.00	218.00
35	286.00	286.00
50	389.00	389.00
70	521.00	521.00
95	716.00	716.00
120	862.00	862.00
150	1,055.00	1,055.00
185	1,296.00	1,296.00
240	1,665.00	1,665.00
300	2,059.00	2,059.00
400	-	-
500	-	-
630	-	-
800	-	-
1000	-	-

SIM



RITTO



SUPER



M^{PRO}



KJL





SIM
Sheet Metal Solution

SIM

CATALOG 2022-2023

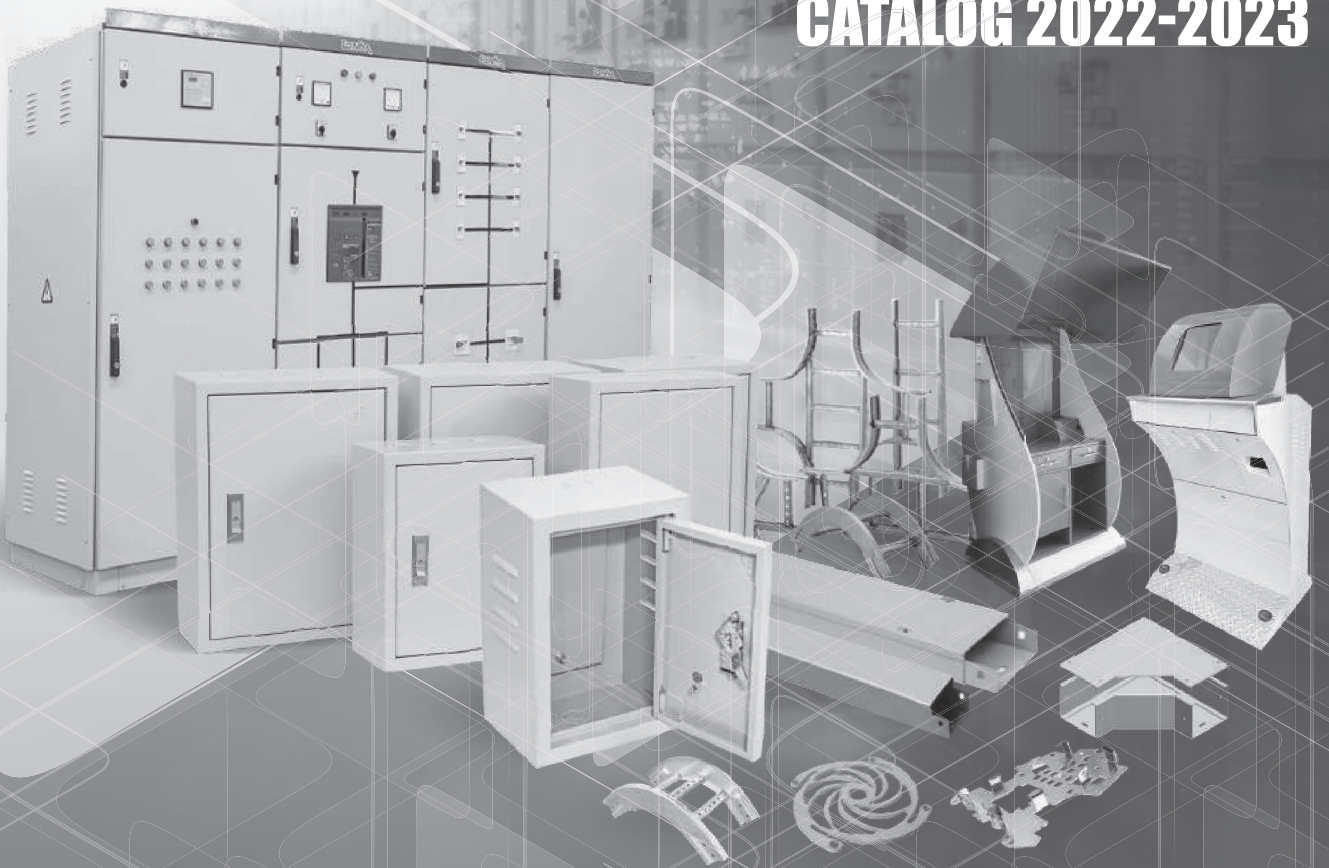

SUPER WALL MOUNTING CABINET



WALL MOUNTING CABINET



INGRESS PROTECTION

ตัวเลขที่บ่งบอกถึงมาตรฐาน การป้องกันฝุ่นกันน้ำ บนอุปกรณ์

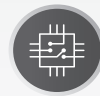

ELECTRIC CIRCUIT



IN DOOR

ตู้ไฟสวิตช์บอร์ดไซส์มาตรฐาน แบบธรรมดา

แบบรุ่น SUPER รุ่น TSLC Series

- เหมาะกับการนำไปติดตั้งเพื่อใช้งานกับวงจรไฟฟ้า
- ขนาดตู้มาตรฐาน 9 ขนาด IP 20
- ความหนาเหล็กมาตรฐาน 0.8-1.0 mm.
- สีครีม (Epoxy Light Cream)
- พ่นสีด้วยระบบ Powder Coating (สีฝุ่น)
- เหมาะสำหรับงานติดตั้งภายในอาคาร



บานเกล็ด ระบายอากาศ



กุญแจดึงล็อกได้



ISOMETRIC

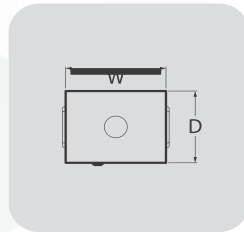

BOTTOM

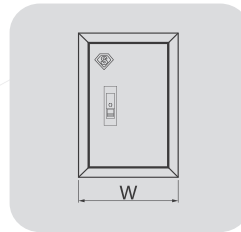

FRONT

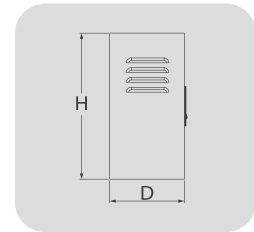

SIDE

Model	Size	Width (mm.)	Height (mm.)	Depth (mm.)	Thickness (mm.)	Price/Unit (Baht)
TSLC-01	00	200	300	150	0.8	455
TSLC-02	0	250	350	150	0.8	530
TSLC-03	1	300	450	170	0.8	600
TSLC-04	2	350	520	170	0.8	725
TSLC-05	3	400	570	200	0.8	890
TSLC-06	4	440	610	230	1.0	1,025
TSLC-07	5	570	690	250	1.0	1,640
TSLC-08	6	600	760	250	1.0	1,910
TSLC-09	7	640	920	250	1.0	2,460

WALL MOUNTING CABINET

SPECIFICATION

Material :	Cold Rolled Steel Sheet
Steel Thickness	Enclosure Size
	Thickness
	TSLC-01 to TSLC-05
TSLC-06 to TSLC-09	1.0 mm.
Finished Surface:	Powder Coated, Light Cream
Supply Includes:	Mounting Plate
Technical Data:	► Suitable for indoor installation
Protection Rating:	► IP 20



MADE TO ORDER

งานสั่งผลิตพิเศษติดต่อ



SUPER WALL MOUNTING CABINET



INGRESS PROTECTION

ตัวเลขที่บ่งบอกถึงมาตรฐาน การป้องกันฝุ่นกันน้ำ บนอุปกรณ์



ELECTRIC CIRCUIT



IN DOOR



OUT DOOR



DUST PROTECTION



WATER PROTECTION



STANDARD ROOF

ตู้ไฟวิทซ์บอร์ดไซส์มาตรฐาน แบบธรรมดา แบนด์ SUPER รุ่น TSLW Series

- เหมาะกับการนำไปติดตั้งเพื่อใช้งานกับวงจรไฟฟ้า
- ขนาดตู้มาตรฐาน 9 ขนาด IP 44
- ความหนาเหล็กมาตรฐาน 0.8-1.0 mm.
- สีครีม (Epoxy Light Cream)
- ฟันสีด้วยระบบ Powder Coating (สีฝุ่น)
- เหมาะสำหรับติดตั้งภายในและภายนอกอาคาร



กุญแจเขาควาย ล็อคได้



ยกขอบกันน้ำ



หลังค้ายื่นกันน้ำ

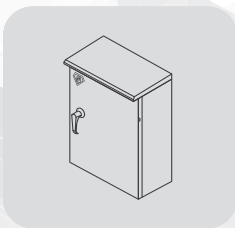
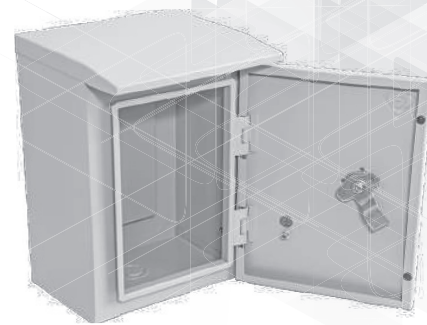

ISOMETRIC

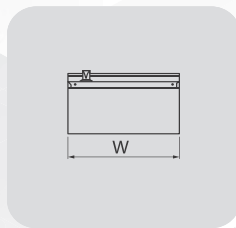

BOTTOM

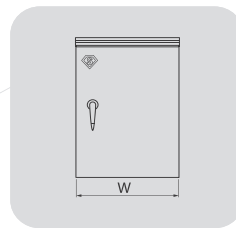

FRONT

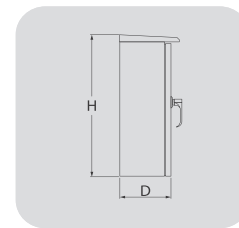

SIDE

Model	Size	Width (mm.)	Height (mm.)	Depth (mm.)	Thickness (mm.)	Price/Unit (Baht)
TSLW-01	00	200	300	150	0.8	725
TSLW-02	0	250	350	150	0.8	770
TSLW-03	1	300	450	170	1.0	865
TSLW-04	2	350	520	170	1.0	1,005
TSLW-05	3	400	570	200	1.0	1,165
TSLW-06	4	440	610	230	1.0	1,400
TSLW-07	5	570	690	250	1.0	2,095
TSLW-08	6	600	760	250	1.0	2,560
TSLW-09	7	640	920	250	1.0	3,490

SPECIFICATION

Material :	Cold Rolled Steel Sheet	
Steel Thickness	Enclosure Size	Enclosure body and Mounting Plate
		Thickness
	TSLW-01 to TSLW-02	0.8 mm.
	TSLW-03 to TSLW-09	1.0 mm.
Finished Surface:	Powder Coated in Epoxy, Light Cream	
Supply Includes:	Mounting Plate	
Technical Data:	▶ Suitable for indoor and outdoor installation	
Protection Rating:	▶ IP 44	



COMPACT ENCLOSURE S.I.M SC IP40 STANDARD



WALL MOUNTING CABINET



INGRESS PROTECTION

ตัวเลขที่บ่งบอกถึงมาตรฐานการป้องกันฝุ่นกับน้ำบนอุปกรณ์



ELECTRIC CIRCUIT



IN DOOR



OUT DOOR



DUST PROTECTION



UV LIGHT PROTECTION

ตู้สวิทช์บอร์ด สำหรับติดตั้งอุปกรณ์ไฟฟ้า แบรนด์ SIM

เป็นตู้สวิทช์บอร์ดกันฝุ่นได้ในระดับ IP40 เหมาะสำหรับการใช้งานภายในอาคาร ผลิตจากเหล็กแผ่นขาวพ่นสีรูป และบริเวณด้านล่างของตัวตู้มีช่องว่างสำหรับร้อยสายไฟเข้าหรือออก พร้อมแผ่นปิดเพื่อความสะอาด ป้องกันไม่ให้สิ่งแปลกปลอมเข้าไปในตัวอีกด้วย ทั้งยังสะดวกในการติดตั้งและการ Wiring สายไฟฟ้า มีให้เลือก 20 รุ่นด้วยกัน

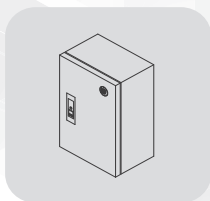
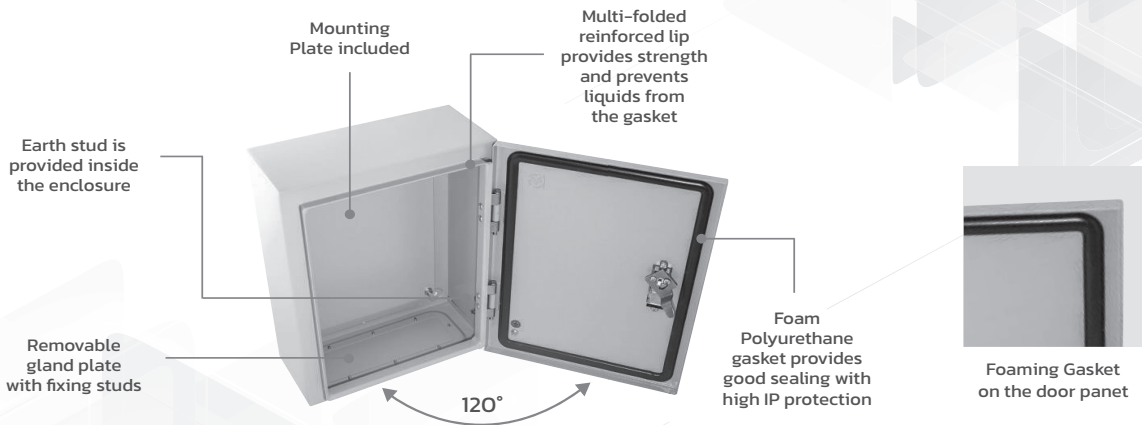

ISOMETRIC

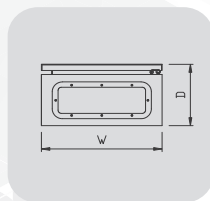

BOTTOM

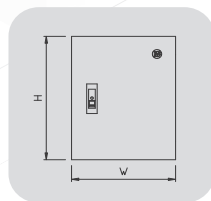

FRONT

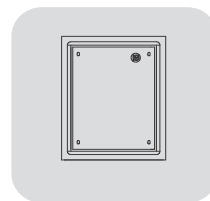

INSIDE

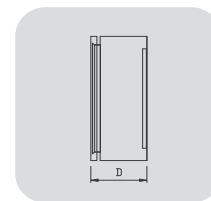

SIDE

Model	Width (mm.)	Height (mm.)	Depth (mm.)	Price/Unit (Baht)
SC-01	280	350	150	600
SC-02	300	450	150	830
SC-03	350	450	150	930
SC-04	300	450	200	950
SC-05	350	450	200	1,000
SC-06	350	500	200	1,100
SC-07	400	500	200	1,200
SC-08	450	600	200	1,290
SC-09	450	600	250	1,350
SC-10	500	600	200	1,450
SC-11	500	600	250	1,550
SC-12	550	700	250	1,750
SC-13	630	750	250	1,820
SC-14	630	900	250	2,300
SC-15	600	1100	250	3,300
SC-16	700	1100	250	3,600
SC-17	800	1200	250	4,000
SC-18	900	1200	250	4,800
SC-19	800	1200	300	5,200
SC-20	900	1200	300	5,500

SPECIFICATION

Material :		Cold Rolled Steel Sheet	
Steel Thickness	Enclosure Size	Enclosure body and Mounting Plate	Door Panel
		Thickness	Thickness
	SC-01 to SC-14	1 mm.	1.5 mm.
	SC-15 to SC-20	1.5 mm.	1.5 mm.
Finished Surface:		Powder Coated in Epoxy, Light Cream	
Supply Includes:		Mounting Plate	
Technical Data:		<ul style="list-style-type: none"> ▶ 4 wall mounting holes on the back panel of the enclosure are provided ▶ Multi-folded prevents the ingress of dust and spray of water when the door panel opens ▶ The front lip of the enclosure is folded to provide rigidity and to form a gutter that prevent liquids from the gasket ▶ Removable bottom gland plate for cable in or out ▶ Doors are provided with zinc alloy housing lock inserted with zinc alloy ▶ Door opens up to 120° ▶ Locking System with S.I.M Lock ▶ Produced by ISO 9001 and ISO 14001 certified factory 	
Protection Rating:		▶ IP40	



MADE TO ORDER

งานสั่งผลิตพิเศษติดต่อ



COMPACT ENCLOSURE S.I.M SCS IP55 STANDARD



WALL MOUNTING CABINET



INGRESS PROTECTION

ตัวเลขที่บ่งบอกถึงมาตรฐานการป้องกันฝุ่นกับน้ำบนอุปกรณ์



ELECTRIC CIRCUIT



IN DOOR



OUT DOOR



DUST PROTECTION



UV LIGHT PROTECTION



WATER PROTECTION



STANDARD ROOF

ตู้สวิตช์บอร์ดสำหรับติดตั้งอุปกรณ์ไฟฟ้าแบบมีหลังคา แบบดัด SIM

เป็นตู้ที่มีลักษณะคล้ายกับรุ่น SC แต่มีคุณสมบัติพิเศษมากกว่า คือ มีหลังคาและสามารถป้องกันฝุ่นและน้ำเข้าตู้ได้ในระดับ IP55 ตู้ประเภทนี้เหมาะสำหรับการติดตั้งกลางแจ้งและภายในอาคาร ประตูด้านหน้ามีวงกบที่พับขึ้นรูปแบบกับขอบยกกันฝุ่นและน้ำเข้าตู้ สามารถปกป้องอุปกรณ์ไฟฟ้าต่างๆที่อยู่ภายในตู้จากฝุ่นและของเหลวได้ นอกจากนี้ที่บริเวณด้านล่างของตู้จะเจาะช่องไว้สำหรับเข้าสายไฟฟ้าพร้อมแผ่นปิด เพื่อป้องกันสิ่งแปลกปลอมเข้าไปภายในตู้ ตู้ผลิตจากแผ่นเหล็กขาวพับขึ้นรูป มีให้เลือก 20 ขนาด

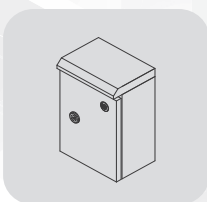
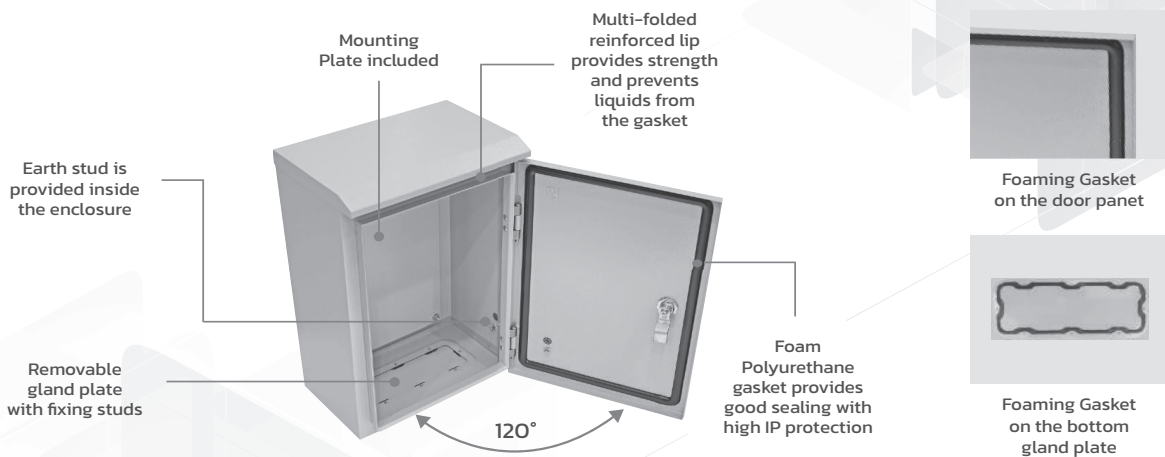

ISOMETRIC

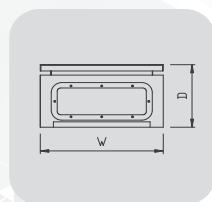

BOTTOM

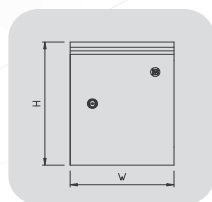

FRONT

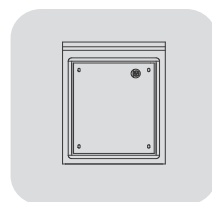

INSIDE

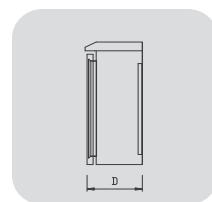

SIDE

Model	Width (mm.)	Height (mm.)	Depth (mm.)	Price/Unit (Baht)
SCS-01	280	350	150	1,050
SCS-02	300	450	150	1,170
SCS-03	350	450	150	1,260
SCS-04	300	450	200	1,290
SCS-05	350	450	200	1,380
SCS-06	350	500	200	1,550
SCS-07	400	500	200	1,695
SCS-08	450	600	200	1,780
SCS-09	450	600	250	1,920
SCS-10	500	600	200	2,100
SCS-11	500	600	250	2,250
SCS-12	550	700	250	2,400
SCS-13	630	750	250	2,750
SCS-14	630	900	250	3,200
SCS-15	600	1100	250	3,880
SCS-16	700	1100	250	4,400
SCS-17	800	1200	250	4,850
SCS-18	900	1200	250	5,200
SCS-19	800	1200	300	5,500
SCS-20	900	1200	300	6,000

SPECIFICATION

Material :	Cold Rolled Steel Sheet
Steel Thickness	Enclosure body and Mounting Plate and Door Panel Thickness 1.5 mm.
Finished Surface:	Powder Coated in RAL 7032
Supply Includes:	Mounting Plate and Bottom Gland Plate
Technical Data:	<ul style="list-style-type: none"> ▶ Enclosure canopies help to protect the electrical components inside the enclosure from a spray of water which can be cause of damage to the components ▶ Multi-folded prevents the ingress of dust and spraying of water when the door panel opens ▶ The front lip of the enclosure is folded to provide rigidity and to form a gutter that prevent liquids from the gasket ▶ Removable bottom gland plate for cable in or out ▶ Doors are provided with zinc alloy housing lock inserted with zinc alloy ▶ Door opens up to 120° / Locking System with S.I.M Lock ▶ Produced by ISO 9001 and ISO 14001 certified factory
Protection Rating:	▶ IP55



MADE TO ORDER

งานสั่งผลิตพิเศษติดต่อ



COMPACT ENCLOSURE S.I.M SCSS IP55 STANDARD



WALL MOUNTING CABINET



INGRESS PROTECTION

ตัวเลขที่บ่งบอกถึงมาตรฐานการป้องกันฝุ่นกับน้ำบนอุปกรณ์

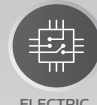

ELECTRIC CIRCUIT



IN DOOR



OUT DOOR



DUST PROTECTION



UV LIGHT PROTECTION



WATER PROTECTION



STANDARD ROOF

ตู้สวิตช์บอร์ดสำหรับติดตั้งอุปกรณ์ไฟฟ้าแบบมีหลังคา ประตูสองชั้น แบนด์ SIM

เป็นตู้ที่มีลักษณะคล้ายกับ SCSS แต่มีคุณสมบัติพิเศษมากกว่า คือ มีประตูสองชั้นซึ่งสามารถ ช่วยปกป้องอุปกรณ์ไฟฟ้าภายในตู้ได้ดียิ่งขึ้น เหมาะสำหรับการใช้งานบริเวณกลางแจ้ง ประตูด้านหน้ามีวงกบชั้นรูปแบบกับขอบยางกันฝุ่นและน้ำ เพื่อป้องกันไม่ให้ฝุ่นและน้ำเข้าไปภายในตู้ สามารถปกป้องอุปกรณ์ไฟฟ้าต่างๆ ที่อยู่ภายในตู้จากฝุ่นและของเหลวได้ในระดับ IP55 นอกจากนี้ที่บริเวณด้านล่างของตู้จะเจาะช่องไว้สำหรับเข้าสายไฟพร้อมแผ่นปิด เพื่อป้องกันสิ่งแปลกปลอมเข้าไปในตู้ ตู้ผลิตจากเหล็กแผ่นขาวขึ้นรูป มีให้เลือก 20 ขนาด

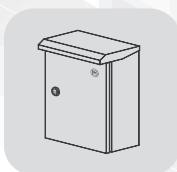
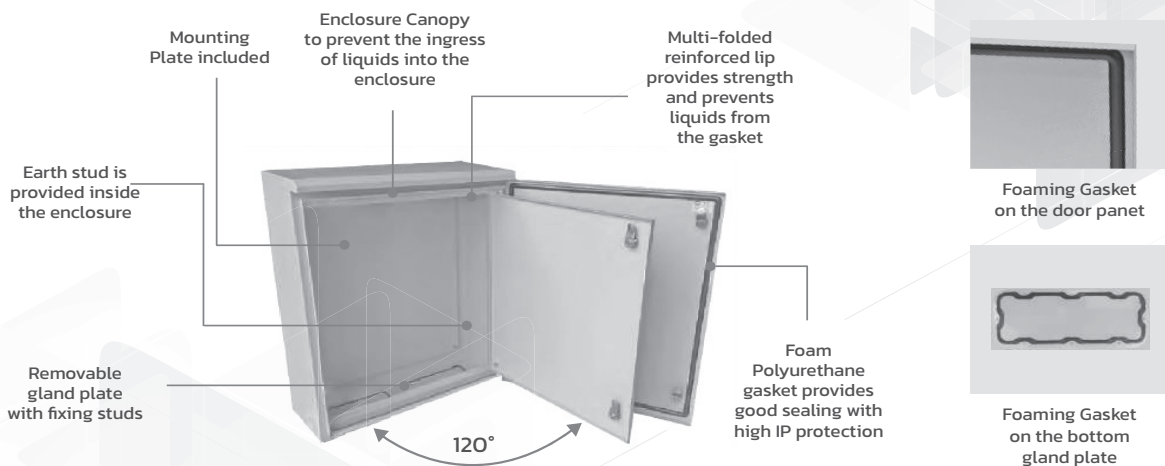

ISOMETRIC

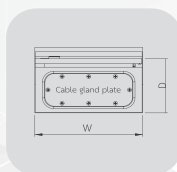

BOTTOM

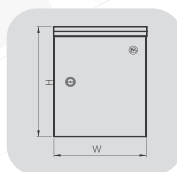

FRONT

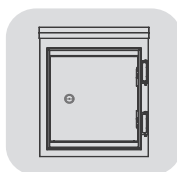

INSIDE DOOR

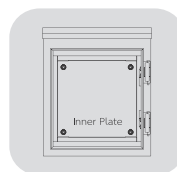

INSIDE

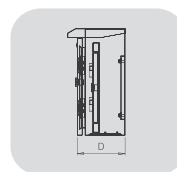

SIDE

Model	Width (mm.)	Height (mm.)	Depth (mm.)	Price/Unit (Baht)
SCSS-01	280	350	150	1,265
SCSS-02	300	450	150	1,460
SCSS-03	350	450	150	1,560
SCSS-04	300	450	200	1,585
SCSS-05	350	450	200	1,650
SCSS-06	350	500	200	1,780
SCSS-07	400	500	200	1,950
SCSS-08	450	600	200	2,150
SCSS-09	450	600	250	2,300
SCSS-10	500	600	200	2,420
SCSS-11	500	600	250	2,465
SCSS-12	550	700	250	2,720
SCSS-13	630	750	250	3,600
SCSS-14	630	900	250	3,870
SCSS-15	600	1100	250	4,250
SCSS-16	700	1100	250	4,950
SCSS-17	800	1200	250	5,100
SCSS-18	900	1200	250	5,600
SCSS-19	800	1200	300	6,000
SCSS-20	900	1200	300	6,500

SPECIFICATION

Material :	Cold Rolled Steel Sheet
Steel Thickness	Enclosure body and Mounting Plate and Door Panel Thickness 1.5 mm.
Finished Surface:	Powder Coated in RAL 7032
Supply Includes:	Mounting Plate and Bottom Gland Plate
Technical Data:	<ul style="list-style-type: none"> ▶ Enclosure canopies help to protect the electrical components inside the enclosure from a spray of water which can be cause of damage to the components ▶ Multi-folded prevents the ingress of dust and spraying of water when the door panel opens ▶ The front lip of the enclosure is folded to provide rigidity and to form a gutter that prevent liquids from the gasket ▶ Removable bottom gland plate for cable in or out ▶ Doors are provided with zinc alloy housing lock inserted with zinc alloy ▶ Door opens up to 120° / Locking System with S.I.M Lock ▶ Produced by ISO 9001 and ISO 14001 certified factory
Protection Rating:	▶ IP55



MADE TO ORDER

งานสั่งผลิตพิเศษติดต่อ



COMPACT ENCLOSURE S.I.M SCSG IP55 STANDARD

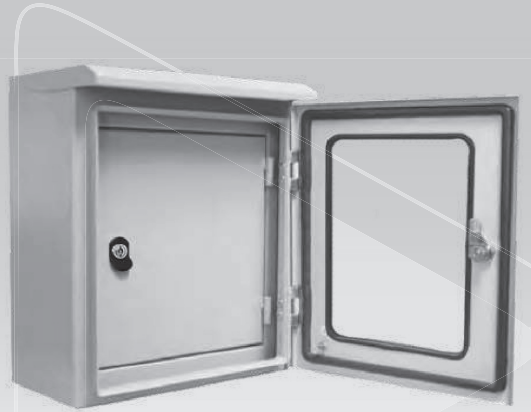

INGRESS PROTECTION

ตัวเลขที่บ่งบอกถึงมาตรฐานการป้องกันฝุ่นกับน้ำตามอุปกรณ์

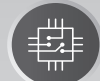

ELECTRIC CIRCUIT



IN DOOR



OUT DOOR



DUST PROTECTION



UV LIGHT PROTECTION



WATER PROTECTION



STANDARD ROOF



GLASS COVERED DOOR

WALL MOUNTING CABINET

ตู้สวิชบอร์ดสำหรับติดตั้งอุปกรณ์ไฟฟ้าแบบประตูสองชั้นมีกระจก แบนด์ SIM

เป็นตู้ที่มีลักษณะคล้ายกับ SCSS แต่มีคุณสมบัติพิเศษมากกว่าคือมีหลังคาและประตูสองชั้นมีกระจกเพื่อง่ายต่อการตรวจเช็คการทำงานของระบบไฟฟ้าภายในตู้ ตู้ประเภทนี้เหมาะสำหรับใช้งานภายนอกอาคารหรือกลางแจ้ง ประตูด้านหน้ามีวงกบที่พับขึ้นรูปแนบกับขอบยางกันฝุ่นและน้ำเพื่อป้องกันไม่ให้ฝุ่นและน้ำเข้าตู้สามารถปกป้องอุปกรณ์ไฟฟ้าต่างๆที่อยู่ภายในตู้จากฝุ่นและของเหลวได้ในระดับ IP55 นอกจากนี้ที่บริเวณด้านล่างของตู้จะเจาะช่องไว้สำหรับเข้าสายไฟพร้อมแผ่นปิด เพื่อป้องกันสิ่งแปลกปลอมเข้าไปภายในตู้ ตู้ผลิตจากเหล็กขาวพับขึ้นรูป มีให้เลือก 20 ขนาด

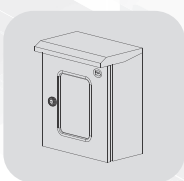
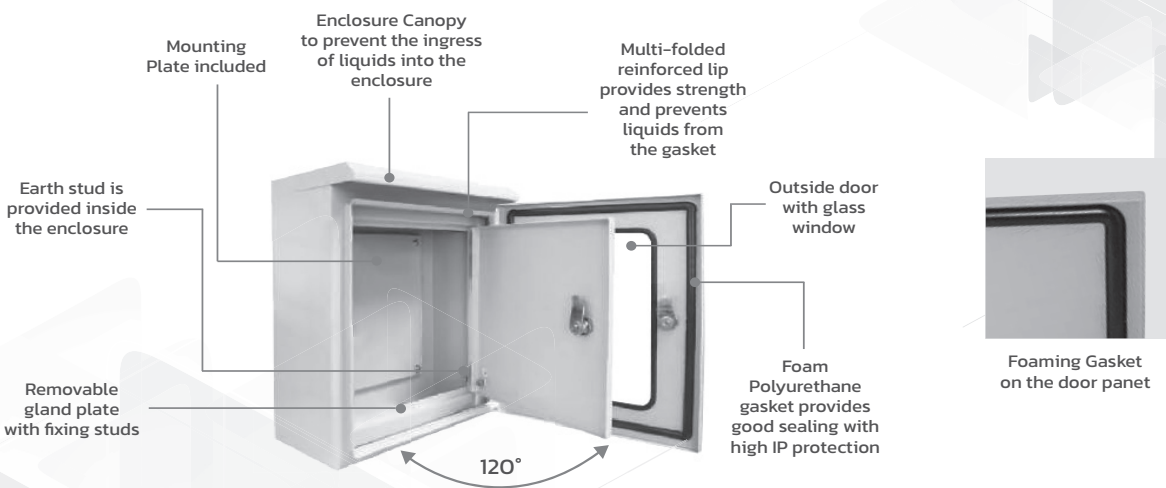

ISOMETRIC

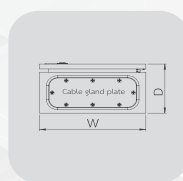

BOTTOM

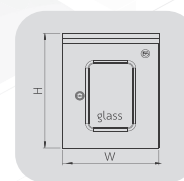

FRONT

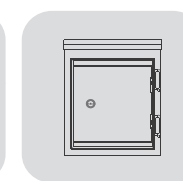

INSIDE DOOR

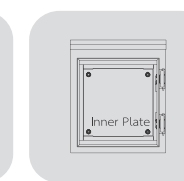

INSIDE

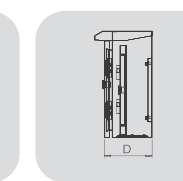

SIDE

Model	Width (mm.)	Height (mm.)	Depth (mm.)	Price/Unit (Baht)
SCSG-01	280	350	150	1,550
SCSG-02	300	450	150	1,770
SCSG-03	350	450	150	1,890
SCSG-04	300	450	200	1,920
SCSG-05	350	450	200	1,980
SCSG-06	350	500	200	2,100
SCSG-07	400	500	200	2,280
SCSG-08	450	600	200	2,400
SCSG-09	450	600	250	2,650
SCSG-10	500	600	200	2,850
SCSG-11	500	600	250	2,970
SCSG-12	550	700	250	3,200
SCSG-13	630	750	250	4,000
SCSG-14	630	900	250	4,550
SCSG-15	600	1100	250	5,100
SCSG-16	700	1100	250	5,500
SCSG-17	800	1200	250	5,800
SCSG-18	900	1200	250	6,300
SCSG-19	800	1200	300	6,800
SCSG-20	900	1200	300	7,200

SPECIFICATION

Material :	Cold Rolled Steel Sheet
Steel Thickness	Enclosure body and Mounting Plate and Door Panel Thickness 1.5 mm.
Finished Surface:	Powder Coated in RAL 7032
Supply Includes:	Mounting Plate and Bottom Gland Plate
Technical Data:	<ul style="list-style-type: none"> ▶ Enclosure canopies help to protect the electrical components inside the enclosure from a spray of water which can be cause of damage to the components ▶ Multi-folded prevents the ingress of dust and spraying of water when the door panel opens ▶ The front lip of the enclosure is folded to provide rigidity and to form a gutter that prevent liquids from the gasket ▶ Removable bottom gland plate for cable in or out ▶ Doors are provided with zinc alloy housing lock inserted with zinc alloy ▶ Door opens up to 120° / Locking System with S.I.M Lock ▶ Produced by ISO 9001 and ISO 14001 certified factory
Protection Rating:	▶ IP55



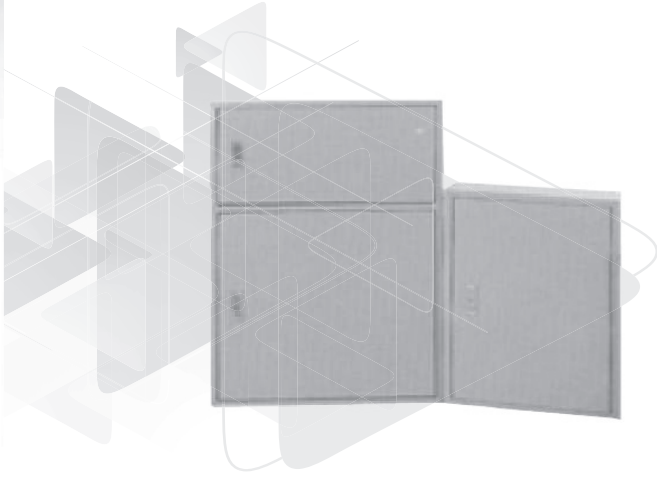

ELECTRIC CIRCUIT



IN DOOR



OUT DOOR



DUST PROTECTION

ตู้แขวนผนังภายในอาคาร รุ่น TD

ตู้ขนาดมาตรฐานรุ่น TD 1-43 พร้อมแผ่นในและกุญแจ สามารถเจาะรูตามรูปร่างและขนาดที่ต้องการ ใส่อุปกรณ์ไฟฟ้าได้สะดวกและรวดเร็วยิ่งขึ้น



A = ความกว้าง
B = ความสูง
C = ความลึก

Model	Width (mm.)	Height (mm.)	Depth (mm.)	Price
TD1	200	300	100	1,000
TD2	200	350	100	1,200
TD3	250	350	100	1,500
TD4	250	400	100	1,800
TD5	300	400	100	1,900
TD6	300	450	100	2,000
TD7	350	400	100	2,100
TD8	350	450	100	2,200
TD9	400	450	100	2,300
TD10	350	500	120	2,400
TD11	400	500	120	2,600
TD12	350	550	120	2,700
TD13	400	550	120	2,800
TD14	450	500	120	2,900
TD15	450	550	120	3,100
TD16	400	600	120	3,200
TD17	450	600	120	3,300
TD18	400	650	120	3,300
TD19	450	650	120	3,400
TD20	500	650	120	3,500
TD21	450	700	120	3,600
TD22	500	700	120	3,800
TD23	450	750	120	3,900
TD24	500	750	120	4,000
TD25	500	800	120	4,100
TD26	550	800	120	4,200
TD27	600	750	120	4,300
TD28	550	850	120	4,500
TD29	600	800	120	4,500



ELECTRIC
CIRCUIT



IN DOOR



OUT DOOR



DUST
PROTECTION

ตู้แขวนผนังรุ่น TD แบบ 2 ตอน

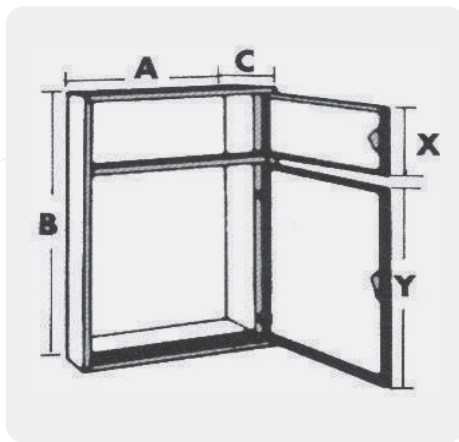

- A = ความกว้าง
- B = ความสูง
- C = ความลึก
- X = ความสูงฝาบน
- Y = ความสูงฝาล่าง

Model	Size (mm)					Price
	Width A	Height B	Height X	Height Y	Depth C	
TD30	600	850			120	4,800
			300	550		5,000
TD31	650	850			150	5,000
			300	550		5,200
TD32	700	800			150	5,200
			300	500		5,300
TD33	600	900			150	5,300
			300	600		5,500
TD34	650	900			150	5,500
			300	600		5,600
TD35	700	900			150	5,600
			300	600		5,800
TD36	600	950			150	5,800
			300	650		6,000
TD37	650	950			150	6,000
			300	650		6,100
TD38	600	1000			150	6,100
			300	700		6,300
TD39	700	1000			150	6,300
			300	700		6,500
TD40	700	1100			150	6,500
			300	800		6,600
TD41	800	1100			150	6,600
			300	800		6,800
TD42	650	1200			200	6,800
			300	900		6,900
TD43	700	1200			200	6,900
			300	900		7,100

WALL MOUNTING CABINET



IN STOCK
สินค้าพร้อมส่ง

MADE TO ORDER
งานสั่งผลิตพิเศษติดต่อ



DESK CONSOLE ENCLOSURES



ELECTRIC CIRCUIT



IN DOOR



DUST PROTECTION

ตู้คอนโซลเดี๊ยง

ตู้เดี๊ยงรุ่น CP ใช้งานในการติดตั้งอุปกรณ์เกี่ยวกับการ Control ต่างๆ เช่น สวิตช์ แผงวงจร หรือ ปุ่มกดต่างๆ เป็นต้น

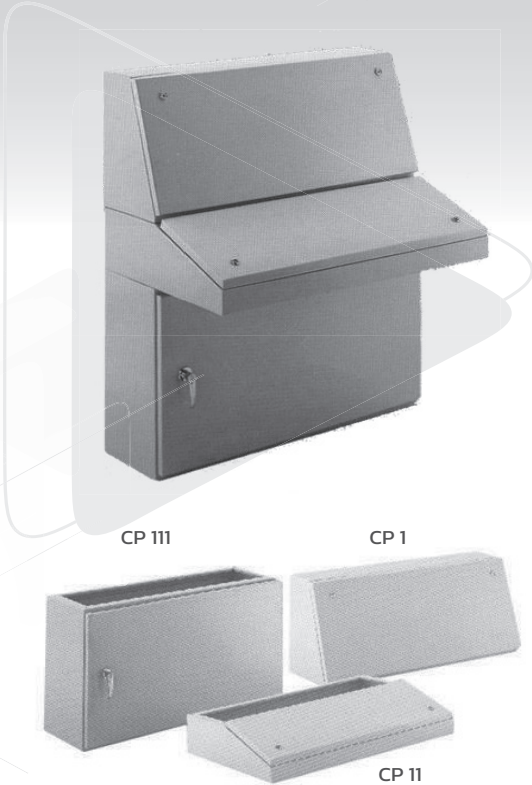

CP 111

CP 1

CP 11

ตัวตู้สามารถถอดประกอบสลับกันได้ 3 ด้าน

CP1 มักใช้ประกอบเป็นส่วนบนสุด

CP11 มักใช้ประกอบเป็นส่วนกลาง

CP111 มักใช้ประกอบเป็นส่วนล่างสุด

ทุกๆส่วนสามารถถอดประกอบสลับกันและเปลี่ยนแปลงเป็นรูปแบบต่างๆตามความต้องการ หรือการใช้งาน นอกจากนี้ยังสามารถสั่งผลิตตามความต้องการของลูกค้าได้



IN STOCK

สินค้าพร้อมส่ง

MADE TO ORDER

งานสั่งผลิตพิเศษติดต่อ



Model	Width (mm.)	Height (mm.)	Depth (mm.)		Price
CP1	600	450	300	170	5,400
CP11	600	200	650	300	6,000
CP111	600	600	300		6,000
ToTal					17,400

CP2	800	450	300	170	6,600
CP12	800	200	650	300	10,000
CP112	800	600	300		10,000
ToTal					26,600

CP3	1000	450	300	170	8,600
CP13	1000	200	650	300	11,300
CP113	1000	600	300		11,300
ToTal					31,200

CP4	1200	450	300	170	10,000
CP14	1200	200	650	300	13,300
CP114	1200	600	300		13,300
ToTal					36,600

CP5	1400	450	300	170	13,300
CP15	1400	200	650	300	16,600
CP115	1400	600	300		16,600
ToTal					46,500

CONFRA MODULAR SYSTEM



MAIN DISTRIBUTION BOARD

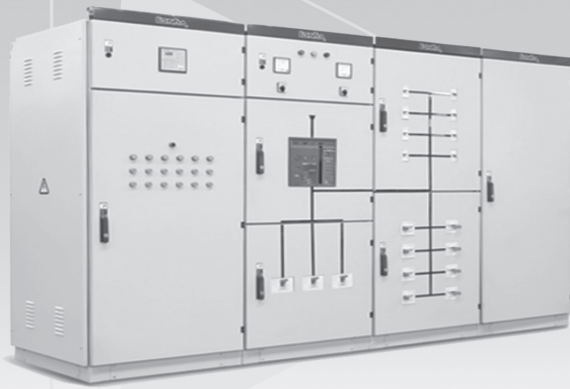

INGRESS PROTECTION

ตัวเลขที่บ่งบอกถึงมาตรฐานการป้องกันฝุ่นกันน้ำบนอุปกรณ์



ELECTRIC CIRCUIT



IN DOOR



DUST PROTECTION



ตู้สวิตช์บอร์ด (CONFRA) ระบบถอดแยกชิ้นส่วน

ตู้สวิตช์บอร์ดระบบถอดแยกชิ้นส่วนประกอบได้ ทันสมัยให้ความสะดวกรวดเร็ว และปลอดภัย

ตู้ MDBI CONFRA รุ่น STRONG เป็นตู้เมนที่ออกแบบมาเป็นพิเศษเพื่อใช้ในระบบจ่ายไฟฟ้า มีขนาดมาตรฐานให้เลือกถึง 7 ขนาดด้วยกันเป็นระบบ Knock down ถอดประกอบ และนำมาต่อกันเป็นโครงตู้ขนาดใหญ่ได้ ตู้ CONFRA ถูกออกแบบให้รับน้ำหนักบัสบาร์ และอุปกรณ์ไฟฟ้าขนาดใหญ่ได้อย่างดี โดยโครงตู้ผลิตจากเหล็กแผ่นอย่างดี ที่มีความหนา 2.0 มม. และยังสามารถสั่งทำโครงตู้ที่มีความหนาพิเศษ 3 มม. ได้อีกด้วย นอกจากนี้ ยังสามารถแบ่งประตูได้ตามที่ลูกค้าต้องการ

ตู้ CONFRA ใช้กุญแจล็อคคีย์หือ Schutzen ที่ออกแบบมาจากประเทศเยอรมัน จึงมั่นใจได้ในอุปกรณ์ล็อค

ตู้ CONFRA รุ่น STRONG ผ่านกระบวนการพ่น และอบสีด้วยระบบอิเล็กโตรสแตติกเป็นสีครีมนุ่ม โดยรุ่นนี้มีมาตรฐานการป้องกันอยู่ที่ IP40

Model	Width (mm.)	Height (mm.)	Depth (mm.)	Price
MDBI-1	600	1800	600	18,500
MDBI-2	800	1800	600	19,800
MDBI-3	800	2100	600	21,100
MDBI-4	800	2100	800	22,400
MDBI-5	1000	2100	600	22,400
MDBI-6	1000	2100	800	23,700
MDBI-7	1000	2100	1000	25,000

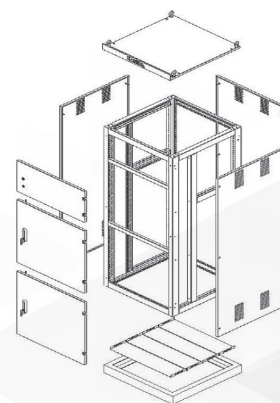

MADE TO ORDER

งานสั่งผลิตพิเศษติดต่อ



Ritto[®]

ริตโต้..ที่สุดแห่งความ ทนทาน



Ritto ผู้นำตู้กันฝุ่นและกันฝน ABS

ประสบการณ์นับ 10 ปี ที่ Ritto ขึ้นชื่อในเรื่องคุณภาพและความทน
เพราะ Ritto ผลิตจากพลาสติก ABS เกรดสูง จึงทนต่อความร้อน
ไม่กลัวสารเคมี ไม่กลัวไฟ...ทนทุกสถานการณ์

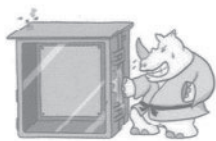

ทนแรงกระแทก



ทนต่อสภาพ หนาว-ร้อน



เจาะรูประกอบง่าย



เป็นฉนวน ปลอดภัย
ไม่ทำไฟฟ้า



กันน้ำและกันซึม



น้ำหนักเบา



มองเห็นด้านในชัดเจน



ดูแลรักษาง่ายไม่เป็นสนิม



ทนความร้อนถึง 80°
และไม่ติดไฟ

ที่สุดของเทคโนโลยีและประสบการณ์

ตู้กันฝุ่นและกันฝน **Ritto** ผลิตจากพลาสติก **ABS*** เป็นตู้ที่สามารถป้องกันการกัดกร่อนในทุกสภาวะอากาศ สามารถป้องกันการซึมจากน้ำและฝุ่นจากภายนอก สามารถทนต่อสภาวะอากาศและสิ่งแวดล้อมที่มีไอกรดเจือปนอยู่ เช่น ในโรงงานอุตสาหกรรมบางประเภท และบริเวณใกล้ชายฝั่งทะเล ซึ่งมีการกัดกร่อนจากไอน้ำเค็ม เป็นต้น

(*Acrylonitrile Butadiene Styrene)

E 200 Series : กล่องพลาสติกแบบฝาพับ ฝาใส พร้อมแผ่นใน (ABS)

- แบบฝาพับ (ABS) รุ่น E
- แบบฝาใส (อะพา-ฟา PC) รุ่น E/T*
- แผ่นใสสำหรับยึดอุปกรณ์ (อะลูซิงค์)



DIMENSION (MM.) ขนาด (มม.)			GRAY COVER แบบพับ (ABS)		TRANSPARENT COVER แบบฟาใส (อะพา-ฟา PC)		ALUZINK MOUNTING PLATE แผ่นยึดอุปกรณ์	
W กว้าง	H สูง	D ลึก	TYPE ชนิด	PRICE ราคา	TYPE ชนิด	PRICE ราคา	TYPE ชนิด	PRICE ราคา
75	125	50	E 201	45.-	N/A	-	N/A	-
110	110	60	E 202	100.-	N/A	-	N/A	-
125	250	90	E 203	210.-	N/A	-	N/A	-
150	150	80	E 204	170.-	E 204/T*	225.-	EMP 204	45.-
200	150	100	E 205	215.-	E 205/T*	275.-	EMP 205	55.-
200	200	100	E 206	250.-	E 206/T*	330.-	EMP 206	70.-
200	300	100	E 207	350.-	E 207/T*	450.-	EMP 207	100.-
250	350	120	E 208	500.-	E 208/T*	590.-	EMP 208	130.-

EU Series : ตู้พลาสติกพร้อมแผ่นในสำหรับยึดอุปกรณ์ (ABS)

- แบบฝาพับ (ABS) รุ่น EU
- แบบฝาใส (อะพา-ฟา PC) รุ่น EUT*

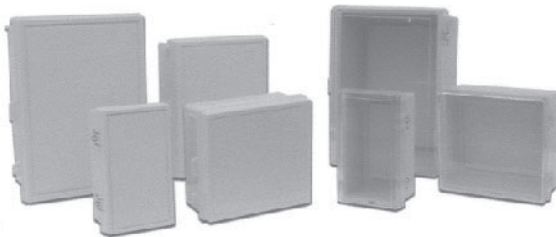

DIMENSION (MM.) ขนาด (มม.)			GRAY COVER แบบพับ (ABS)		TRANSPARENT COVER แบบฟาใส (อะพา-ฟา PC)	
W กว้าง	H สูง	D ลึก	TYPE ชนิด	PRICE ราคา	TYPE ชนิด	PRICE ราคา
180	300	130	EU 1	380.-	EUT* 1	465.-
300	280	130	EU 2	535.-	EUT* 2	675.-
300	410	150	EU 3	770.-	EUT* 3	1,010.-
350	480	180	EU 4	1,050.-	EUT* 4	1,330.-

EU Series : ตู้พลาสติกกันฝุ่นกันฝน (มีหลังคา) พร้อมแผ่นในสำหรับยึดอุปกรณ์ (ABS)

- แบบฝาพับ (ABS) รุ่น EUR
- แบบฝาใส (อะพา-ฟา PC) รุ่น EUR/T*

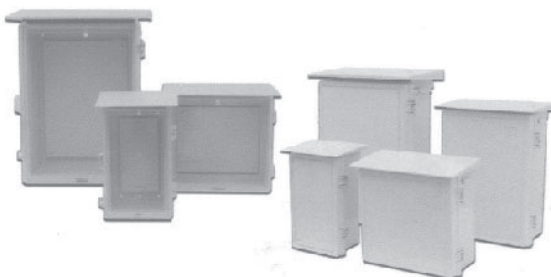

DIMENSION (MM.) ขนาด (มม.)			GRAY COVER แบบพับ (ABS)		TRANSPARENT COVER แบบฟาใส (อะพา-ฟา PC)	
W กว้าง	H สูง	D ลึก	TYPE ชนิด	PRICE ราคา	TYPE ชนิด	PRICE ราคา
180	320	130	EUR 1	450.-	EUR/T* 1	560.-
300	300	130	EUR 2	650.-	EUR/T* 2	810.-
300	430	150	EUR 3	930.-	EUR/T* 3	1,170.-
350	510	180	EUR 4	1,250.-	EUR/T* 4	1,540.-

นอกจากนี้ตู้กับฝุ่นและกันฝนที่ผลิตจากพลาสติกเอบีเอส จะมีมาตรฐานความคงทนแข็งแรงในการใช้งานอย่างมาก สามารถทนต่อความร้อนได้แม้อุณหภูมิสูง ไม่ติดไฟ โดยได้รับการทดสอบคุณสมบัติมาตรฐานการทนทานต่อสารเคมี คุณสมบัติความคงทนแข็งแรงและคุณสมบัติกันความร้อน

Riito ABS (Acrylonitrile Butadiene Styrene) plastic cabinet are the fully corrosion protection. Cabinets are made of the ABS, plastic which can resist in severe weather condition exposure, impervious to dust and moisture. The cabinets are also proof in standard mechanical properties and thermal properties, inflammability comply with DIN 4102 part B2.

EP Series : ตู้พลาสติกพร้อมแผ่นในสำหรับยึดอุปกรณ์ (ABS)

- แบบฝาทึบ (ABS) รุ่น EP
- แบบฝาใส (เฉพาะฝา PC) รุ่น EPT*

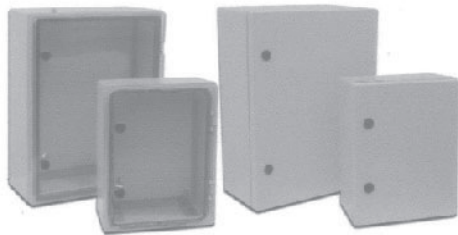

DIMENSION (MM.) ขนาด (มม.)			GRAY COVER แบบทึบ (ABS)		TRANSPARENT COVER แบบใส (เฉพาะฝา PC)	
W กว้าง	H สูง	D ลึก	TYPE ชนิด	PRICE ราคา	TYPE ชนิด	PRICE ราคา
310	410	180	EP 1	1,250.-	EPT* 1	1,550.-
420	520	220	EP 2	2,250.-	EPT* 2	2,675.-
450	600	220	EP 3	2,675.-	EPT* 3	3,375.-
550	700	250	EP 4	3,600.-		

EP Series : ตู้พลาสติกกันฝุ่นกันฝน (มีหลังคา) พร้อมแผ่นในสำหรับยึดอุปกรณ์ (ABS)

- แบบฝาทึบ (ABS) รุ่น EPR
- แบบฝาใส (เฉพาะฝา PC) รุ่น EPR/T*



DIMENSION (MM.) ขนาด (มม.)			GRAY COVER แบบทึบ (ABS)		TRANSPARENT COVER แบบใส (เฉพาะฝา PC)	
W กว้าง	H สูง	D ลึก	TYPE ชนิด	PRICE ราคา	TYPE ชนิด	PRICE ราคา
310	430	180	EPR 1	1,470.-	EPR/T* 1	1,850.-
420	550	220	EPR 2	2,600.-	EPR/T* 2	3,250.-
450	650	220	EPR 3	3,500.-	EPR/T* 3	4,350.-
550	750	250	EPR 4	4,500.-		

PHYSICAL PROPERTIES OF ABS, PC MATERIALS

	Standard	Unit	PC	ABS
● Mechanical Properties				
Impact strength at+23°C	DIN 53453	KJ/m ²	No failure	No failure
Impact strength at+40°C	DIN 53453	KJ/m ²	No failure	-
Notch Impact strength aK+ 23°C	DIN 53453	KJ/m ²	20-30	14.7
Elasticity modulus	DIN 53457	MPa	2300	2140
● Thermal Properties				
Vicat softening temp. VST/B	DIN 53460	°C	148	95
Long term service temp.	warm	°C	115-130	70
Flammability	UL 94		V2/VO	HB
● Electrical Properties				
Dielectric strength Ed	DIN 53481	KV/mm	>30	35
Tracking resistance KC/F	DIN 53480	grading	200-225	500
● Physical Properties				
Water absorption in std.atm	DIN 53495	%	0.15	-
Density	DIN 53479	g/cm ³	1.2	1.04

ตู้กันฝุ่นและกันฝน ABS ทนกว่า...ค้ำกว่า Ritto ABS (Acrylonitrile Butadiene Styrene)

ตู้กันฝุ่นและกันฝน ผลิตจากพลาสติก ABS ป้องกันการกัดกร่อนทุกสภาวะอากาศอย่างเต็มที่
Ritto ABS* plastic cabinet are the fully corrosion protection

*(Acrylonitrile Butadiene Styrene)

กล่องและตู้พลาสติกสำหรับงานระบบไฟฟ้า Ritto เหมาะอย่างยิ่งในการใช้งานในสถานที่ต่างๆ น้ำหนักเบา ราคาประหยัด จึงใช้แทนสแตนเลสและอลูมิเนียมได้ดี ติดตั้งอุปกรณ์ต่างๆ ได้ง่าย ไม่ต้องใช้เครื่องมือหนักๆ ในการเจาะรูหน้าตู้ เบาลงในการยกติดตั้ง มีฝาใส่ให้ล็อก ไม่ต้องสั่งทำเป็นพิเศษ สามารถเห็นอุปกรณ์ในตู้ได้สะดวก สวยงาม มีหลายขนาดให้เลือกทั้งที่เป็นกล่องหรือเป็นตู้ สามารถเลือกใช้ได้สะดวก สวยงาม เมื่อเปรียบเทียบกับกล่องและ ตู้พลาสติกยี่ห้ออื่นๆ เราเหนือกว่าทุกกรณี เพราะ Ritto ใช้วัสดุที่เลือกสรรและพิถีพิถันได้ว่าทนทานต่อสภาพเหล่านั้นอย่างแน่นอน

กล่องและฝาสีเทาของ Ritto ผลิตจากวัตถุดิบ ABS แบบเดียวกับที่ใช้ผลิตกันชนรถยนต์ จึงทนทานและไม่กลัวแสงแดดกว่า PVC เนื่องจาก PVC โดยปกติออกแบบให้ใช้ในที่ๆไม่มีแสงแดด เช่น ท่อน้ำใช้ฝังดิน หรือท่อสายไฟฟ้าใช้ฝังผนัง ABS มีความหยุ่นตัว จึงเจาะรูเพื่อยึดอุปกรณ์หน้าตู้ได้สะดวก แต่ไม่แตกง่ายไม่เหมือน PVC ซึ่งเปราะและแตกได้ง่าย

รุ่นฝาใส ผลิตจากวัตถุดิบ PC แบบเดียวกับที่ใช้ผลิตขวดนม จึงทนทานและมีความหยุ่นตัวแบบ ABS และสามารถมองเห็นภายในตู้ ซึ่งอาจเกิดสิ่งผิดปกติได้อย่างชัดเจน ไม่ขุ่นมัวแม้ต้องตากแดดตลอดเวลาใช้งาน

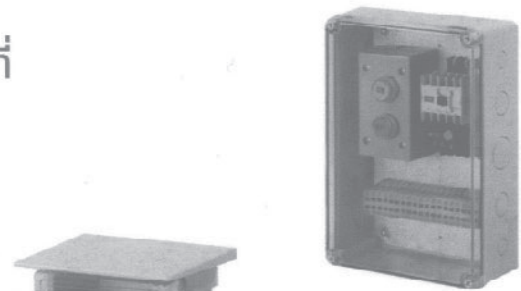

ตู้แบบมดึก รีเลย์และเทอร์มิออล

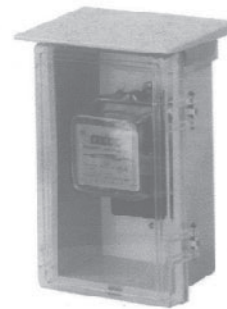

ตู้โมดูลในตู้แบบฝาใสเห็นง่าย เช็ดจนไม่เป็นสนิม (ตรงบานพับที่ใช้ใส่รูของเหล็ก)

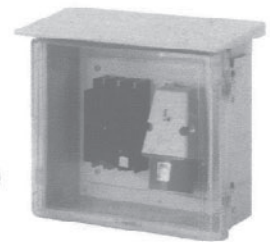

ตู้โมดูลแบบต่างๆ ไร้สำหรับ Junction box และเจาะเพื่อติดตั้ง Cable Gland ได้

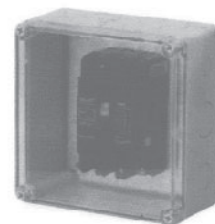

ตู้โทรศัพท์ทุกจอเงิน หรือ อุปกรณ์อื่น



Ritto
New Generation of Enclosures

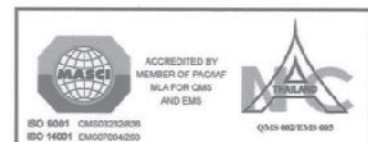

PANASONIC

Panasonic
ideas for life

PAT



ARROW

Arrowpipe

NIPPON



NIPPON
WHITE CONDUIT

DAIWA

DAIWA
WHITE CONDUIT & ACCESSORIES

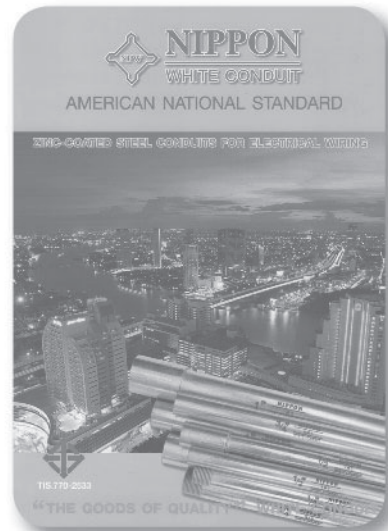
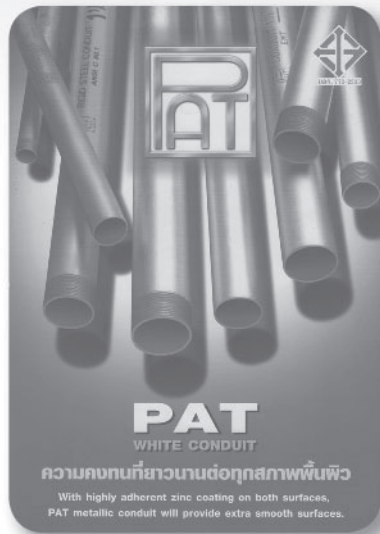
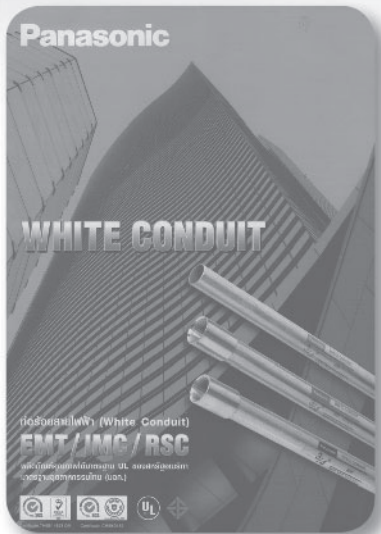

Size	ท่อร้อยสายไฟ		
	EMT	IMC	RSC
1/2"	133	282	342
3/4"	192	375	436
1"	273	506	641
1 1/4"	476	653	828
1 1/2"	555	802	985
2"	688	1,096	1,317
2 1/2"	-	1,714	-
3"	-	2,122	-
3 1/2"	-	2,440	-
4"	-	2,802	-

STEEL CITY



SC



















CONDUITS & FITTINGS

 ท่อเหล็กขุ่นบาง	 ท่อเหล็กขุ่นหนา	 ท่อโค้งขุ่นบาง	 ท่อโค้งขุ่นหนา	
 แคลมป์จับท่อขาคี่ตรง	 แคลมป์จับท่อขาคี่	 คอนเน็คเตอร์ท่อขาคี่	 ขี้นท่อขาคี่	
 คอนเน็คเตอร์ท่อขาคี่	 ขี้นท่อขาคี่	 คอนเน็คเตอร์ท่อขาคี่ขุ่นพิเศษ	 เฮ็น.เฮ็น.คอนเน็คเตอร์	 ซีคสันคูปป์
 บุชซี้ง	 ซีคคี่	 นาซีฆวสท	 ท่อขาคี่ขุ่นขั้ว	 แหวนสท
 คอนเน็คเตอร์ท่อขาคี่กันน้ำ	 ขี้นท่อขาคี่กันน้ำ	 คอนเน็คเตอร์ท่อขาคี่กันน้ำ	 คอนเน็คเตอร์ท่อขาคี่กันน้ำ 45°	 คอนเน็คเตอร์ท่อขาคี่กันน้ำ 90°
 ท่อขาคี่เหล็ก	 ท่อขาคี่กันน้ำ	 ท่อขาคี่กันน้ำซีคคี่	 คอนเน็คเตอร์ท่อขาคี่กันน้ำซีคคี่	 ซีคคอนเน็คเตอร์กันน้ำ

CONDUIT BODIES AND JUNCTION BOXES

 แชนคี่บ็อกซ์ 2" x 4"	 ฝาปิดแชนคี่บ็อกซ์ 2" x 4"	 เฮ็น.เค.บ็อกซ์ 3" x 3"	
 สแควร์บ็อกซ์ 4" x 4"	 ฝาปิดสแควร์บ็อกซ์ 4" x 4"	 สแควร์บ็อกซ์ 4" x 4" รุ่น 4 พู	
 ยูโรป้าบ็อกซ์	 ฝาปิดมิด พับขอบ	 ซีคคี่บ็อกซ์	 ฝาปิดซีคคี่บ็อกซ์
 เซฟ.เฮส.บ็อกซ์ 2" x 4"	 ฝาปิด เซฟ.เฮส.บ็อกซ์ 2" x 4"	 เซฟ.เฮส.บ็อกซ์ 4" x 4"	 ฝาปิด เซฟ.เฮส.บ็อกซ์ 4" x 4"

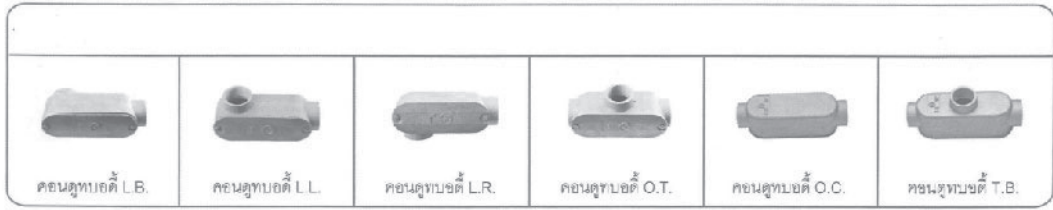
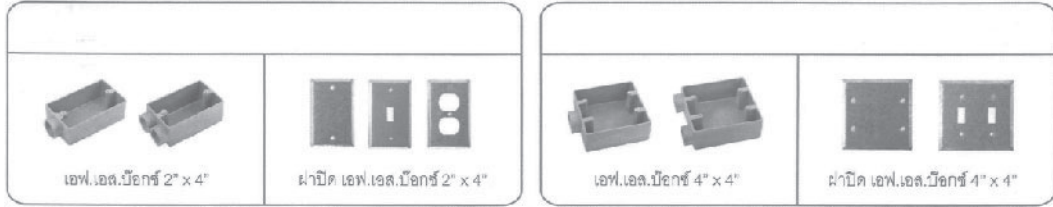
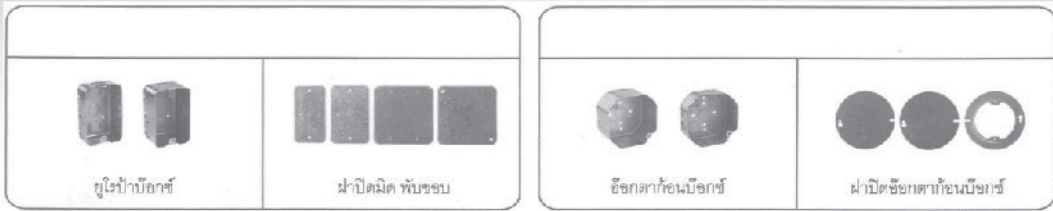

CONDUIT BODIES AND JUNCTION BOXES

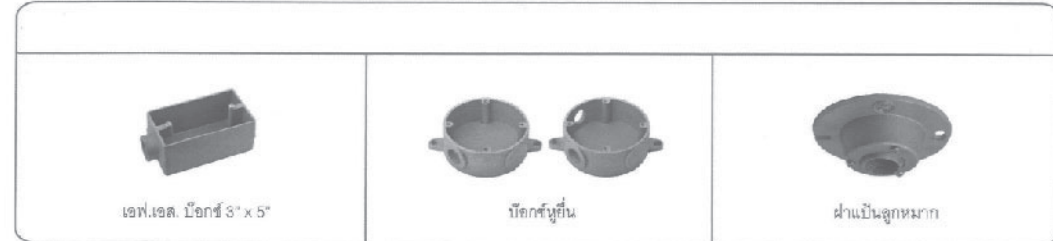

C - CHANNEL & ACCESSORIES



CLAMPS & HANGERS

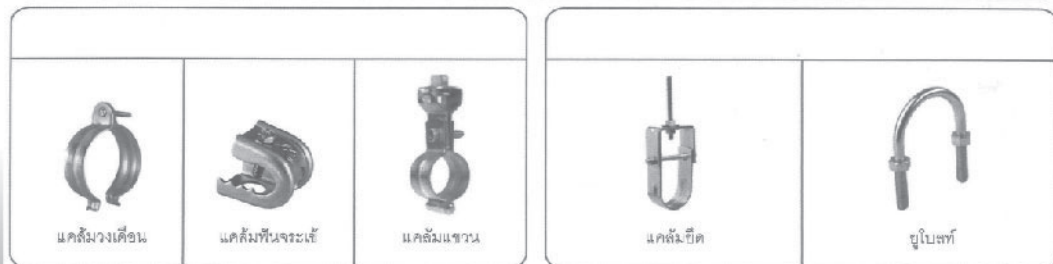

ELECTRICAL TERMINAL LUGS

<p>หางปลาทองแดงรุ่นหนา (CL)</p>		<p>หางปลาทองแดงรุ่นหนา (CL)</p>		<p>ข้อต่อสายไฟทองแดง (CS)</p>		
<p>หางปลาทองแดงแบบขี้เป็ด (R)</p>		<p>หางปลาทองแดงแบบขี้หมู (RF)</p>		<p>หางปลาทองแดงแบบขี้เป็ด (Y)</p>		
<p>หางปลาทองแดงแบบขี้หมู (YF)</p>	<p>หัวเสียบตัวเมีย กลม-หุ้ม (F-A)</p>	<p>หัวเสียบตัวผู้ กลม-หุ้ม (F-B)</p>	<p>หัวเสียบตัวเมีย แบบ-หุ้ม (V)</p>	<p>หัวเสียบตัวผู้ แบบ-หุ้ม (V)</p>	<p>หัวเสียบตัวเมีย แบบ-หุ้มเติม (PV)</p>	<p>หัวเสียบแบบก้านไม้ขีด (PIN-AF)</p>
<p>ข้อต่อสายขี้หมู (BF)</p>	<p>หัวนมวกต่อสาย (N)</p>	<p>ข้อต่อขี้หมูปลายสายเป็ด (CN)</p>	<p>ข้อต่อขี้หมูปลายสายหุ้ม (CE)</p>		<p>ปลอกหุ้มหางปลา</p>	









LIGHTNING PROTECTION & GROUNDING CONNECTION

<p>ฐานล่อฟ้า</p>			<p>เสาล่อฟ้า</p>		
<p>ส้อมฟ้าสามแฉก</p>	<p>แฉกกราวด์หรือด</p>	<p>กราวด์หรือดทองแดง</p>	<p>กราวด์เทสมือกซ์</p>		
<p>แฉกจับบาร์ทองแดง</p>	<p>แฉกจับสายทองแดงเป็ด</p>	<p>ยูแฉก 2 สก</p>	<p>หางปลาทองแดงขันสกรู</p>	<p>ผงเชื่อม</p>	<p>PERMANENT MOLD</p>
<p>ฉนวน 2 ทาง (CC)</p>	<p>ฉนวน 3 ทาง (CC)</p>	<p>ฉนวน 4 ทาง (CC)</p>	<p>ฉนวน สาย + บาร์ (CB)</p>		
<p>ฉนวน 1 ทางลงกราวด์ (GR)</p>	<p>ฉนวน 2 ทางลงกราวด์ (GT)</p>	<p>ฉนวน 3 ทางลงกราวด์ (NT)</p>	<p>ฉนวน 4 ทางลงกราวด์ (XT)</p>		

HIGH & LOW VOLTAGE UTILITIES

 แบริ่งสายไฟฟ้า	 สกรูยึดชุดขั้วสาย	 พรีฟอร์มเคเบิล		
 ลูกถ้วย	 แหวนสี่เหลี่ยม	 พี.จี. แคสึม	 พี.จี. แคสึมมีเยื่อ 2 สกรู	 แคสึมลูกตาด

ELECTRICAL CABINETS & CASES

 กล่องพลาสติกแบบฝาพับ	 หุ้ดมีฮาร์ท	 ตู้วงเหล็ก	 ยางกันขนาดรอบตู้
 ตู้พลาสติก รุ่น EU	 ตู้พลาสติกกันน้ำ รุ่น EU	 ตู้พลาสติก รุ่น EP	 ตู้พลาสติกกันน้ำ รุ่น EP

WIRE WAY & ACCESSORIES

 รางไฟร้อย	 ตัวแขวนรางไฟร้อย	 อุปกรณ์เสริม งอจากเปิดผ่านบน	 อุปกรณ์เสริม งอจากเปิดผ่านใน	 อุปกรณ์เสริม งอจากเปิดผ่านขวา	 อุปกรณ์เสริม 3 ทาง	 อุปกรณ์เสริม 4 ทาง
--	---	--	--	---	---	--

WIRE ACCESSORIES

 ปิดงา	 วาล์ว นัท	 ใส่โถใส่สำหรับพันรวมสาย		
 จอยส์ คอมเปาน์ด	 ดักซีล คอมเปาน์ด	 น้ำยาร้อยสาย	 เพ็ชรเซอร์คิลิป	 เคเบิลแกน

OTHER ACCESSORIES

 ปลั๊กคีมบอชิน	 ปลั๊กคีมบีล	 ปลั๊กฝังติดโบลท์	 เกลียวลวด	 ท่อหนาช่วงสั้น	
 ฝาของเหล็กฝังพื้น	 ลูกตุ้มน้ำยวพลาสติก	 ลูกตุ้มน้ำยวอลูมิเนียม	 แหวนลวด	 จุกตุ้มน้ำ	 ลูกยาง
 สกรูเกลียววงเหล็ก (เกลียวปล่อย)	 น๊อตพลาสติก	 ปลั๊กฝัง			



ท่อร้อยสายไฟยูพีวีซี
uPVC CONDUITS

CLIPSAL

CLIPSAL[®]
electricimagination[™]

HACO

HACO[®]
Electric Solutions

MULTI
UTILITIES

PANASONIC

Panasonic
ideas for life

BTICINO

bticino

SCHNEIDER ELECTRIC

Schneider
Electric

HACO

HäCO[®]
Electric Solutions

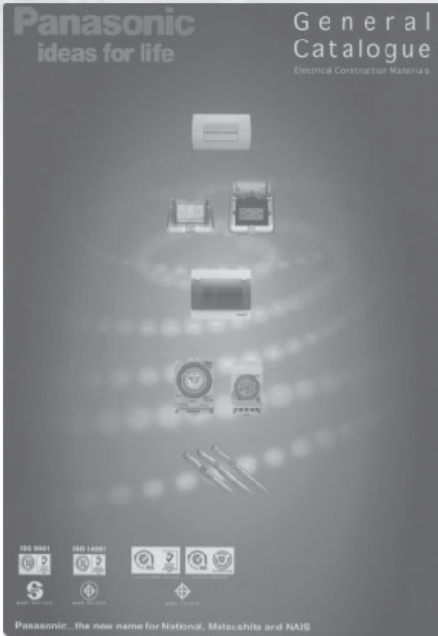

Schneider



ABB



MITSUBISHI



เซอร์กิตเบรกเกอร์และมิเตอร์

CIRCUIT BREAKERS AND WATT-HOUR METERS



ผลิตภัณฑ์สำหรับอาคารพาณิชย์
และอาคารสำนักงาน (R-ET) 2006

SQUARE D
by Schneider Electric

Residential & Building Solutions Products

- > Enclosure / ตู้ควบคุมพลังงาน
- > MCB / รีเลย์ฟิวส์อัตโนมัติ
- > RCD / อุปกรณ์ตัดกระแสรั่วสแตนด์บาย/สำรอง
- > MCCB / รีเลย์ฟิวส์อัตโนมัติ
- > Surge Protection Device / อุปกรณ์ป้องกันความดัน
- > Safety Switch / อุปกรณ์ตัดกระแส
- > Accessories / อุปกรณ์เสริม

IEC

Schneider Electric
Effective December 2006

LV Air Circuit Breakers
LV Moulded-Case Circuit Breakers

ABB

MITSUBISHI ELECTRIC

Changes for the Better
WS SERIES

Production line of switchgear components

- Molded-Case Circuit Breakers
- Earth-Leakage Circuit Breakers
- Air Circuit Breakers
- Magnetic Motor Starters
- Current Transformers
- Potential Transformers
- Indicating Meters
- Power Capacitors
- Power Factor Controllers
- White Conduits



มิเตอร์วัดไฟฟ้า (รุ่นจานหมุน) "MITSUBISHI" Watt Hour Meters

TYPE	AMPERE	VOLT	PRICE
MF-33E 1P2W	5A(15A)	220V	1,800
	15A(45A)	220V	2,000
	30A(100A)	220V	3,500
	50A(150A)	220V	4,000

TYPE	AMPERE	VOLT	PRICE
MH-96H	5A(CT)	220V/380V	7,500
MH-96 3P4W	15A(45A)	220V/380V	9,000
	30A(100A)	220V/380V	10,500
	50A(150A)	220V/380V	11,000
MH-96HV	5A(CT)	220V/380V	16,500



มิเตอร์วัดไฟฟ้าอิเล็กทรอนิกส์ (รุ่นมาตรฐาน) "MITSUBISHI" Electronic Watt Hour Meters

TYPE	AMPERE	VOLT	PRICE
SX1-A30E	5A(45A)	220V	2,400
MX2-A02E	10A(100A)	220V	11,000
MX2-C02E	10A(100A)	220V/380V	12,500
MX2-C42E	5A(CT)	220V/380V	12,000
MX2-B42E	5A(CT)	110V/220V	11,500

*การใช้งานเหมือนจานหมุน ไม่มีระบบสื่อสาร



SX-1



MX 2

มิเตอร์วัดไฟฟ้าอิเล็กทรอนิกส์ (รุ่นอัตโนมัติ) "MITSUBISHI" Electronic Watt Hour Meters

TYPE	AMPERE	VOLT	PRICE
SX1-A31N	5A(45A)	220V	3,000
MX2-A01E	10A(100A)	220V	10,500
MX2-C01E	10A(100A)	220V/380V	13,500
MX2-C41E	5A(CT)	220V/380V	13,500

*รายละเอียดโปรแกรม และอุปกรณ์สื่อสารกรุณาติดต่อร้านค้า

SUNNY



VCK



SUNNY CATALOG

A leader in the emergency lighting
market for more than 42 years



2021

LIGHT FOR LIFE

sunnyemergencylight.com

เว็บไซต์



คู่มือการใช้



ไฟฉุกเฉิน
EMERGENCY LIGHT

CU Series



Battery Checker
With Sound Alert



Auto Test
Every 30 Days 30 Mins



Remote Test
5 Secs / 30 Mins /
60 Mins



Battery
Sealed Lead Acid (SLA)

WARRANTY

หลอด LED **10 ปี** วงจรเครื่อง **5 ปี** แบตเตอรี่ **3 ปี**

REMOTE TEST
RT-S1



Model	Lamp		Battery Capacity	Back-up (hr)	Back-Up Time Compare to Battery Life (Approx)			Dimension (mm)			Weight (kg)
	Bulb	Watts			1 year (min)	2 year (min)	3 year (min)	L	W	H	
CU209CD4	2	9	12V - 5.0Ah	4.0	240	170	110	250	80	230	3.27
CU209CD6	2	9	12V - 7.0Ah	6.0	360	250	160				3.68
CU212CD3	2	12	12V - 5.0Ah	3.0	180	125	80				3.27
CU212CD4	2	12	12V - 7.0Ah	4.0	240	170	110				3.68

SN Series



Manual Test



Battery
Sealed Lead Acid (SLA)

WARRANTY

หลอด LED **10 ปี** วงจรเครื่อง **5 ปี** แบตเตอรี่ **2 ปี**

Model	Lamp		Battery Capacity	Back-up (hr)	Dimension (mm)			Weight (kg)
	Bulb	Watts			L	W	H	
SN203NC7	2	3	6V - 4.5Ah	7.0	210	70	220	2.10

SG Series



Auto Test
Every 30 Days 30 Mins



Battery
Sealed Lead Acid (SLA)

WARRANTY

หลอด LED 5 ปี
วงจรเครื่อง 5 ปี
แบตเตอรี่ 2 ปี

Model	Lamp		Battery Capacity	Back-up (hr)	Dimension (mm)			Weight (kg)
	Bulb	Watts			L	W	H	
SG509-02	2	9	12V-1.3Ah	3.0	210	70	215	1.95

SG SERIES



NEW!
2023

มั่นใจ! กับระบบใหม่ที่มี
AUTO CHECK



Auto Check Auto Test Lithium Phosphate 3 Steps Charger

Model	Lamp		Battery Capacity	Back-up (hr)	Dimension (mm)			Weight (kg)
	Bulb	Watts			L	W	H	
SG209CD2	2	9	3.2V-6000mAh	2.0	210	70	215	1.24
SG209CD4	2	9	3.2V-6000mAhx2	4.0	210	70	215	1.40
SG212CD3	2	12	3.2V-6000mAhx2	3.0	210	70	215	1.40

TM SERIES



NEW!
2023

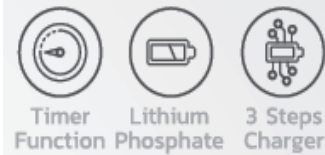

Timer Function Lithium Phosphate 3 Steps Charger

Model	Lamp		Battery Capacity	Back-up (hr)	Dimension (mm)			Weight (kg)
	Bulb	Watts			L	W	H	
TM209CD2	2	9	3.2V-6000mAh	2.0	210	70	215	1.50

EDLS Series



Auto Test
Every 30 Days 30 Mins

AT Deactivation
Can be Selected

Remote Test
5 Secs / 30 Mins / 60 Mins

3 Steps Charger
New Innovation

REMOTE TEST
RT-S3



Battery
LifePO4

WARRANTY

หลอด LED 10 ปี วงจรชาร์จ 5 ปี แบตเตอรี่ 3 ปี

Model	Lamp		Battery Capacity	Back-up (hr)	Back-Up Time Compare to Battery Life (Approx)			Dimension (mm)		Weight (kg)
	Bulb	Watts			1 year (min)	2 year (min)	3 year (min)	W	H	
EDLS09-3C	1	9	LiFePO4	3.0	120	90	60	140	47	0.66
EDLS09-2R	1	9	6.4V-1200 mAh	3.0	120	90	60	140	42	0.48

EDLT Series

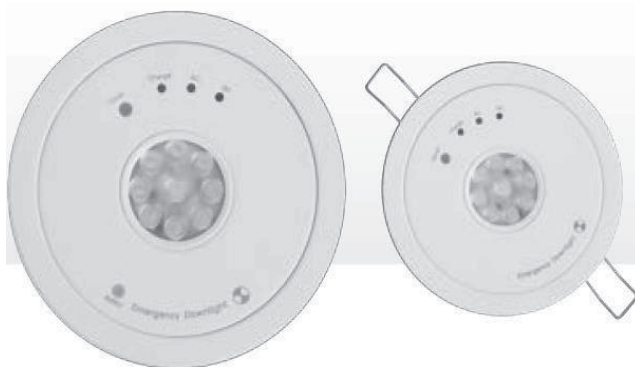

Replacement
For Regular Lamp

Timer
Turn On/Off Light Automatically

Remote Control
Setting time 1, 2, 3, 6, 12 hrs.

3 Steps Charger
New Innovation

REMOTE CONTROL
RT-S2



Battery
LiFePO4)

WARRANTY

หลอด LED 3 ปี วงจรชาร์จ 5 ปี แบตเตอรี่ 3 ปี

Model	Lamp		Battery Capacity	Back-up (hr)	Back-Up Time Compare to Battery Life (Approx)			Dimension (mm)		Weight (kg)
	Bulb	Watts			1 year (min)	2 year (min)	3 year (min)	W	H	
EDLT09-3C	1	9	LiFePO4)	3.0	120	90	60	140	47	0.66
EDLT09-3R	1	9	6.4V-1200 mAh	3.0	120	90	60	140	42	0.48

EMERGENCY EXIT SIGN LIGHTLIGHT

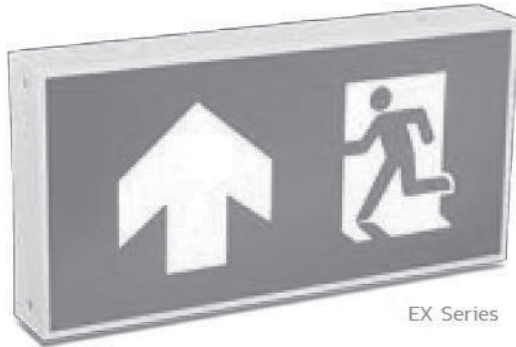

EX Series



SL Series

WARRANTY
EX/SL SERIES 1-5*

หลอด LED 3 ปี
วงจรเครื่อง 5 ปี
แบตเตอรี่ 3 ปี

* EX Series 3 รับประกันแบตเตอรี่ 2 ปี



LED Lamp Power
10w



Back Up Time
2 hours



Symbol Height
10cm



Battery
Ni-MH

EX/SL SERIES 1

Model	Sided	Battery Capacity	Led Strip Lamp	Back-up (hr)	Back-Up Time Compare to Battery Life (Approx)			Dimension (mm)			Weight (kg)			
					1 year (min)	2 year (min)	3 year (min)	L	W	H				
EX Series 1														
EXS1-10LED/S	1	Ni-MH 3.6V-1800 mAh	10W	2.0	135	120	80	400	60	195	1.70			
EXS1-10LED/D	2										1.40			
SL Series 1														
SLS1-10LED / S (C)	1	Ni-MH 3.6V-1800 mAh	10W	2.0	135	120	80	410	80	220	1.70			
SLS1-10LED / S (W)	1													
SLS1-10LED / D (C)	2													
SLS1-10LED / S (R)	1										430	100	220	1.78
SLS1-10LED / D (R)	2													



LED Lamp Power
10w



Back Up Time
3 hours



Symbol Height
10cm



Battery
Ni-MH

EX/SL SERIES 2

Model	Sided	Battery Capacity	Led Strip Lamp	Back-up (hr)	Back-Up Time Compare to Battery Life (Approx)			Dimension (mm)			Weight (kg)			
					1 year (min)	2 year (min)	3 year (min)	L	W	H				
EX Series 2														
EXS2-10LED / S	1	Ni-MH 3.6V-2100 mAh	10W	3.0	180	160	120	400	60	195	1.80			
EXS2-10LED / D	2										1.50			
SL Series 2														
SLS2-10LED / S (C)	1	Ni-MH 3.6V-2100 mAh	10W	3.0	180	160	120	410	80	220	1.80			
SLS2-10LED / S (W)	1													
SLS2-10LED / D (C)	2													
SLS2-10LED / S (R)	1										430	100	220	1.88
SLS2-10LED / D (R)	2													



LED Lamp Power
10w



Back Up Time
3.5 hours



Symbol Height
10cm



Battery
SLA

EX SERIES 3

EX Series 3											
EXS3-10LED / S	1	12V - 13Ah	10W	3.5	210	190	150	500	80	200	2.30
EXS3-10LED / D	2										2.00

DIMENSION EX SERIES 3



WARRANTY EX/SL SERIES

หลอด LED 3 ปี
วงจรหรือ 5 ปี
แบตเตอรี่ 2 ปี

* EX Series 3 รับประกันแบตเตอรี่ 2 ปี



LED Lamp Power
10w



Back Up Time
2-3 hours



Symbol Height
10cm



Battery
Ni-MH



Auto Test
Every 30 Days
30 Mins



Remote Test
5 Secs / 30 Mins /
60 Mins

REMOTE TEST RT-S1



EX/SL SERIES 4

EX Series 4														
EXS4-10LED / S	1	Ni-MH 3.6V-1800 mAh	10W	2.0	135	120	80	400	60	195	1.70			
EXS4-10LED / D	2										1.40			
EXS4-10LED / S	1	Ni-MH 3.6V-2100 mAh	10W	3.0	180	160	120	400	60	195	1.80			
EXS4-10LED / D	2										1.50			
SL Series 4														
SLS4-10LED / S (C)	1	Ni-MH 3.6V-1800 mAh	10W	2.0	135	120	80	410	80	220	1.70			
SLS4-10LED / S (W)	1										430	100	220	1.78
SLS4-10LED / D (C)	2													
SLS4-10LED / S (R)	1													
SLS4-10LED / D (R)	2	Ni-MH 3.6V-2100 mAh	10W	3.0	180	160	120	410	80	220	1.80			
SLS4-10LED / S (W)	1										430	100	220	1.88
SLS4-10LED / D (C)	2													
SLS4-10LED / S (R)	1													
SLS4-10LED / D (R)	2													



LED Lamp Power
12w



Back Up Time
2 hours



Symbol Height
15cm



Battery
Ni-MH

EX/SL SERIES 5

Model	Sided	Battery Capacity	Led Strip Lamp	Back-up (hr)	Back-Up Time Compare to Battery Life (Approx)			Dimension (mm)			Weight (kg)						
					1 year (min)	2 year (min)	3 year (min)	L	W	H							
EX Series 5																	
EXS5-12LED / S	1	Ni-MH 3.6V-2100 mAh	12W	2.0	135	120	80	480	60	230	1.80						
EXS5-12LED / D	2										1.50						
SL Series 5																	
SLS5-12LED / S (C)	1	Ni-MH 3.6V-2100 mAh	12W	2.0	135	120	80	505	80	275	2.30						
SLS5-12LED / S (W)	1										135	120	80	525	100	275	2.50
SLS5-12LED / D (C)	2																
SLS5-12LED / S (R)	1																
SLS5-12LED / D (R)	2																

EXSC Series

WARRANTY
EXSC SERIES / FIRE HOST SIGN

หลอด LED 3 ไร่
วงจรเครื่อง 5 ไร่
แบตเตอรี่ 2 ไร่



DIMENSION



Model	Sided	Battery Capacity	Led Strip Lamp	Back-up (hr)	Dimension (mm)			Weight (kg)
					L	W	H	
EXSC-20LED / S	1	12V - 2.9Ah	20W	4.0	750	100	200	4.00
EXSC-20LED / D	2							3.50
EXSC-30LED / S	1	12V - 5Ah	30W	4.0	1300	120	300	11.00
EXSC-30LED / D	2							10.50

FIRE HOST SIGN Series

DIMENSION

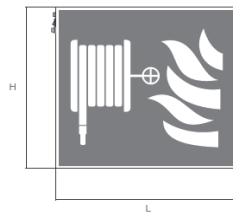

EXFH-1S

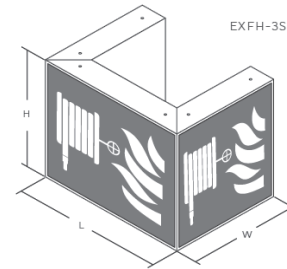

EXFH-3S

Model	Sided	Battery Capacity	Led Strip Lamp	Back-up (hr)	Dimension (mm)			Weight (kg)
					L	W	H	
EXFH-1S	1	12V - 2.9Ah	20W	4.0	500	100	450	5.00
EXFH-3S	3	12V - 5Ah	60W	2.0	575	470	450	12.00

INSTALLATION

SL SERIES
TYPES OF MOUNTING OPTIONS

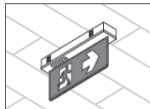

Ceiling (Type C)
(Installation without accessories)

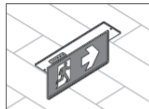

Recessed (Type R)
(Installation without accessories)



Wall (Type W)
(Installation without accessories)

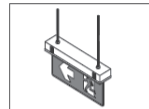

Suspended
(Installation with kit not included)

EX SERIES
TYPES OF MOUNTING OPTIONS



Ceiling
(Installation without accessories)



Wall
(Installation without accessories)

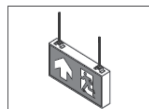

Suspended
(Installation with kit not included)

LEGEND PANEL FORMAT

STANDARD LEGEND FORMAT
(EIT STANDARD 021004-18)



SD-001



SD-002



SD-003



SD-004



SD-005



SD-006

CU-IP66 Series



REMOTE TEST RT-S1



Weatherproof
IP66



Remote Test
5 Secs / 30 Mins / 60 Mins



Battery
Sealed Lead Acid (SLA)



Battery Checker
With Sound Alert



Auto Test
Every 30 Days 30 Mins

WARRANTY

หลอด LED 2 ปี วงจรสำรอง 2 ปี แบตเตอรี่ 2 ปี

Model	Lamp		Battery Capacity	Back-up (hr)	Dimension (mm)			Weight (kg)
	Bulb	Watts			L	W	H	
CU209ST4	2	9	12V - 5.0Ah	4.0	270	90	250	3.84
CU212ST3	2	12	12V - 5.0Ah	3.0				

EXST Series



Weatherproof
IP66



Symbol Height
10cm



Battery
Ni-MH



LED Lamp Power
10w



Back Up Time
2, 3 hours

WARRANTY

หลอด LED 2 ปี วงจรสำรอง 2 ปี แบตเตอรี่ 2 ปี

Model	Sided	Battery Capacity	Led Strip Lamp	Back-up (hr)	Dimension (mm)			Weight (kg)
					L	W	H	
EXST-10LED / S	1	Ni-MH 3.6V - 1800	10W	2.0	450	80	230	3.20
EXST-10LED / D	2							4.20
EXST-10LED / S	1	Ni-MH 3.6V - 2100	10W	3.0	450	80	230	3.20
EXST-10LED / D	2							4.20

REMOTE LAMP

RST Series

 Weatherproof
IP66



RST SERIES

TYPES OF MOUNTING OPTIONS

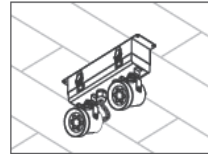

Ceiling (Type C)
(installation without accessories)

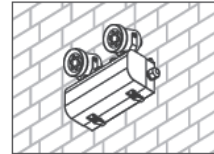

Wall (Type W)
(installation without accessories)

DIMENSION

SURFACE CEILING

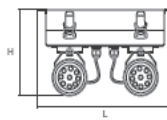

SURFACE WALL

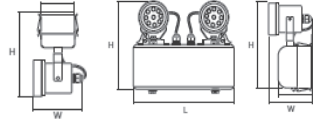

REMOTE LAMP RST SERIES							
Model	Input Voltage	LED Lamp Power	Lamp (Bulb)	Lumen (lm)/ Bulb	Dimension L x W x H (mm)	Weight (g)	Mounted
RST 12-209(C)	12VDC	9W	2	810	245 x 95 x 150	1,010	Surface Ceiling
RST 12-212(C)	12VDC	12W	2	1,080	245 x 95 x 150	1,010	Surface Ceiling
RST 12-209(W)	12VDC	9W	2	810	210 x 95 x 180	1,010	Surface Wall
RST 12-212(W)	12VDC	12W	2	1,080	210 x 95 x 180	1,010	Surface Wall
RST 220-209(C)	220VAC	9W	2	810	245 x 95 x 150	1,010	Surface Ceiling
RST 220-212(C)	220VAC	12W	2	1,080	245 x 95 x 150	1,010	Surface Ceiling
RST 220-209(W)	220VAC	9W	2	810	210x 95 x 180	1,010	Surface Wall
RST 220-212(W)	220VAC	12W	2	1,080	210x 95 x 180	1,010	Surface Wall

CCU 12V

Series

FIGURE A



FIGURE B



FIGURE C



FIGURE D



Manual Test



Battery
Sealed Lead Acid (SLA)

WARRANTY

ประกัน 5 ปี

ประกัน 2 ปี

CCU 12V									
Model	Output Voltage	Maximum Power Load	Battery Capacity	Back-up (hr)	Dimension (mm)			Weight (kg)	Figure
					L	W	H		
CCU 12-30	12VDC	30W	12V - 7.0Ah	2.0	290	80	160	4.37	A
CCU 12-50	12VDC	50W	12V - 12Ah	2.0	290	110	160	6.37	B
CCU 12-60		60W	12V - 15Ah		340	100	220	8.49	
CCU 12-80		80W	12V - 18Ah		340	100	220	9.42	
CCU 12-120		120W	12V - 26Ah		340	160	235	13.14	
CCU 12-180		180W	12V - 40Ah		400	200	250	19.49	
CCU 12-250		250W	12V - 26Ahx2		500	200	250	30.60	
CCU 12-300	300W	12V - 65Ah	33.90						
CCU 12-350	350W	12V - 40Ahx2	42.00						
CCU 12-470	470W	12V - 100Ah	46.00						
CCU 12-620	12VDC	620W	12V - 130Ah	2.0	620	350	750	76.00	D
CCU 12-720		720W	12V - 150Ah					77.00	
CCU 12-1000		1000W	12V - 200Ah					99.50	
CCU 12-1100		1100W	12V - 130Ahx2		620	400	950	119.00	
CCU 12-1400		1400W	12V - 150Ahx2					125.00	
CCU 12-1900		1900W	12V - 200Ahx2					171.00	

CCU 24V

Series

FIGURE C



FIGURE D



Manual Test



Battery
Sealed Lead Acid (SLA)

WARRANTY

ประกัน 5 ปี

ประกัน 2 ปี

CCU 24V									
Model	Output Voltage	Maximum Power Load	Battery Capacity	Back-up (hr)	Dimension (mm)			Weight (kg)	Figure
					L	W	H		
CCU 24-170	24VDC	170W	12V - 18Ahx2	2.0	400	200	250	26.60	C
CCU 24-240		240W	12V - 26Ahx2		500	200	250	41.00	
CCU 24-360		360W	12V - 40Ahx2		500	250	300	56.00	
CCU 24-500	24VDC	500W	12V - 55Ahx2	2.0	620	350	750	63.10	D
CCU 24-600		600W	12V - 65Ahx2					74.70	
CCU 24-700		700W	12V - 40Ahx4					100.00	
CCU 24-950		950W	12V - 100Ahx2		600	300	950	104.00	
CCU 24-1100		1100W	12V - 130Ahx2					130.00	
CCU 24-1200		1200W	12V - 65Ahx4					135.00	
CCU 24-1440		1440W	12V - 150Ahx2		620	400	950	136.00	
CCU 24-1900		1900W	12V - 200Ahx2					181.00	
CCU 24-2200		2200W	12V - 130Ahx4					228.00	

INV 220V Series



3 Steps Charger
New Innovation



Auto Test
Every 30 Days 30 Mins

WARRANTY

ประกันสินค้า 1 ปี
ประกันเครื่อง 5 ปี
แบตเตอรี่ 2 ปี



Battery
Sealed Lead Acid (SLA)



Low Voltage
Sound Indicator

FIGURE V1

DIMENSION



FIGURE V2

DIMENSION



FIGURE V3

DIMENSION



FIGURE V4

DIMENSION



FIGURE V5

DIMENSION



FIGURE V6

DIMENSION



INV 220V

Model	Output Voltage	Maximum Power Load (Wattage @PF = 1)	Battery Capacity	Back-up (hr)	Dimension (mm)			Weight (kg)	Figure
					L	W	H		
INV 220-200	220VAC	200W	24V-33Ah (12V-33Ah x 2)	2.0	440	230	660	26.50	V1
INV 220-300		300W	24V-40Ah (12V-40Ah x 2)						
INV 220-400		400W	24V-55Ah (12V-55Ah x 2)						
INV 220-500		500W	24V-65Ah (12V-65Ah x 2)	2.0	600	250	810	55.60	V2
INV 220-700		700W	24V-100Ah (12V-100Ah x 2)						
INV 220-1000		1000W	24V-150Ah (12V-150Ah x 2)						
INV 220-1200		1200W	48V-100Ah (12V-100Ah x 4)	2.0	620	400	1200	150.00	V4
INV 220-1500		1500W	48V-130Ah (12V-130Ah x 4)						
INV 220-2000		2000W	48V-150Ah (12V-150Ah x 4)						
INV 220-2500		2500W	48V-200Ah (12V-200Ah x 4)	2.0	620	600	1200	214.00	V5
INV 220-3000		3000W	48V-260Ah (12V-130Ah x 8)						
					2.0	800	600	1500	398.00

REMOTE LAMP

RCD Series



RCD SINGLE LAMP / DOUBLE LAMP SERIES
TYPES OF MOUNTING OPTIONS

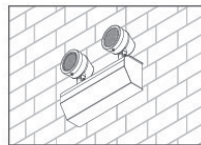
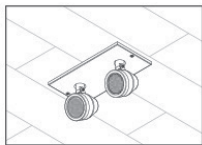
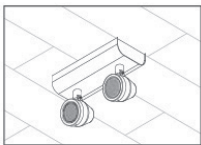
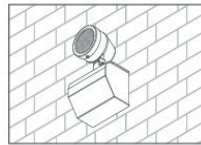
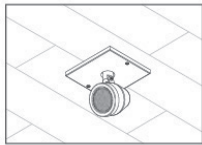

Ceiling (Type C)
(Installation without accessories)

Recessed (Type R)
(Installation without accessories)

Wall (Type W)
(Installation without accessories)

DIMENSION
SINGLE LAMP / DOUBLE LAMP

RECESSED CEILING

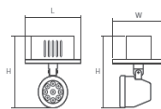

SURFACE CEILING

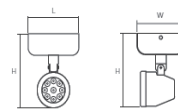

SURFACE WALL

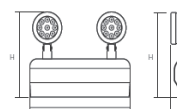
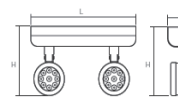
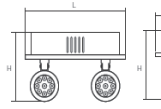
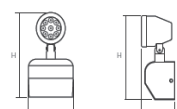

REMOTE LAMP RCD 12V SERIES

Model	Input Voltage	LED Lamp Power	Lamp (Bulb)	Lumen (lm)/ Bulb	L x W x H (mm) Recessed Ceiling	L x W x H (mm) Surface Ceiling	L x W x H (mm) Surface Wall	Weight (g)
RCD12-109	12VDC	9W	1	810	110 x 102 x 130	90 x 85 x 125	90 x 76 x 155	440/360/380
RCD12-112	12VDC	12W	1	1,080	110 x 102 x 130	90 x 85 x 125	90 x 76 x 155	440/360/380
RCD12-209	12VDC	9W	2	810	205 x 102 x 130	200 x 85 x 125	200 x 76 x 155	820/710/730
RCD12-212	12VDC	12W	2	1,080	205 x 102 x 130	200 x 85 x 125	200 x 76 x 155	820/710/730

REMOTE LAMP RCD 24V SERIES

Model	Input Voltage	LED Lamp Power	Lamp (Bulb)	Lumen (lm)/ Bulb	L x W x H (mm) Recessed Ceiling	L x W x H (mm) Surface Ceiling	L x W x H (mm) Surface Wall	Weight (g)
RCD24-109	24VDC	9W	1	810	110 x 102 x 130	90 x 85 x 125	90 x 76 x 155	440/360/380
RCD24-112	24VDC	12W	1	1,080	110 x 102 x 130	90 x 85 x 125	90 x 76 x 155	440/360/380
RCD24-209	24VDC	9W	2	810	205 x 102 x 130	200 x 85 x 125	200 x 76 x 155	820/710/730
RCD24-212	24VDC	12W	2	1,080	205 x 102 x 130	200 x 85 x 125	200 x 76 x 155	820/710/730

REMOTE LAMP RCD 220V SERIES

Model	Input Voltage	LED Lamp Power	Lamp (Bulb)	Lumen (lm)/ Bulb	L x W x H (mm) Recessed Ceiling	L x W x H (mm) Surface Ceiling	L x W x H (mm) Surface Wall	Weight (g)
RCD220-109	220VAC	9W	1	810	110 x 102 x 130	90 x 85 x 125	90 x 76 x 155	440/360/380
RCD220-112	220VAC	12W	1	1,080	110 x 102 x 130	90 x 85 x 125	90 x 76 x 155	440/360/380
RCD220-209	220VAC	9W	2	810	202 x 102 x 130	200 x 85 x 125	200 x 76 x 155	820/710/730
RCD220-212	220VAC	12W	2	1,080	202 x 102 x 130	200 x 85 x 125	200 x 76 x 155	820/710/730

ACCESSORIES & RECHARGABLE BATTERIES

ACCESSORIES

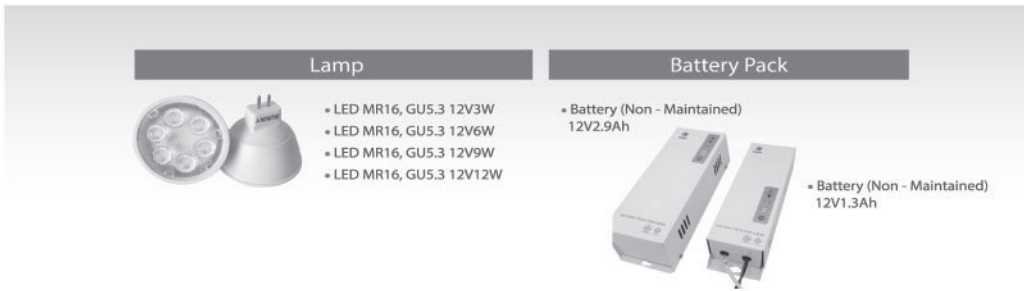
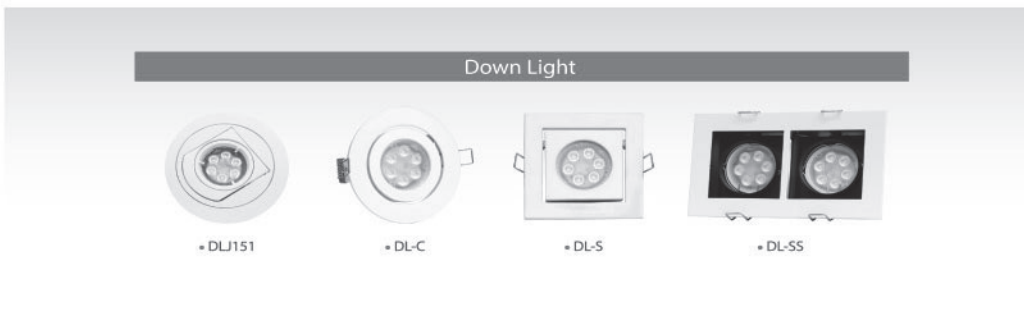
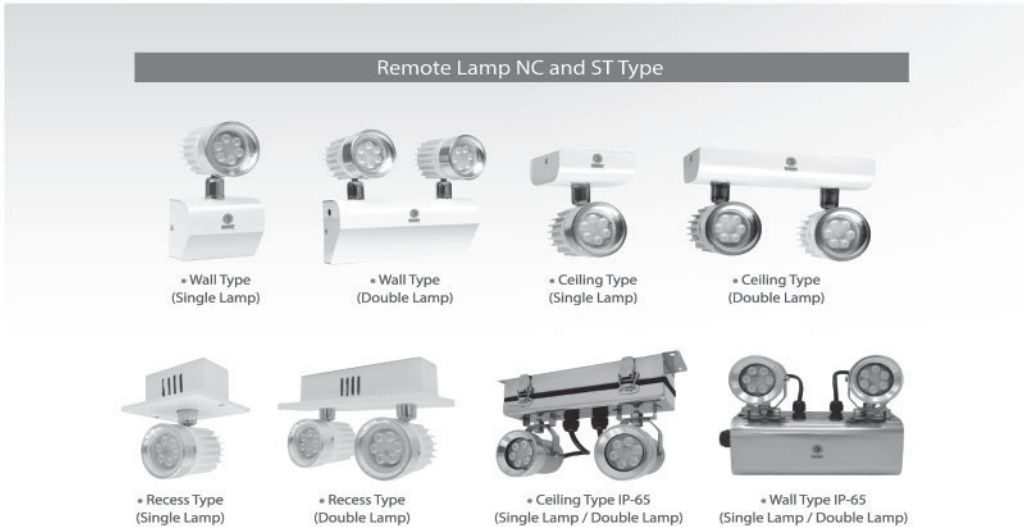

RECHARGABLE BATTERIES



Sealed Lead Acid Maintenance Free & Specification (Sealed Lead acid battey)



Hightemp Nickel Metal Hydride Bettery



โคมและอุปกรณ์กันระเบิด
EXPLOSION PROOF

CROUSE-HINDS

Crouse-Hinds
by **EAT-N**

BOSSTON



KUMWELL

Kumwell
Grounding & Lightning Protection System

RAYCHEM

Raychem[®]



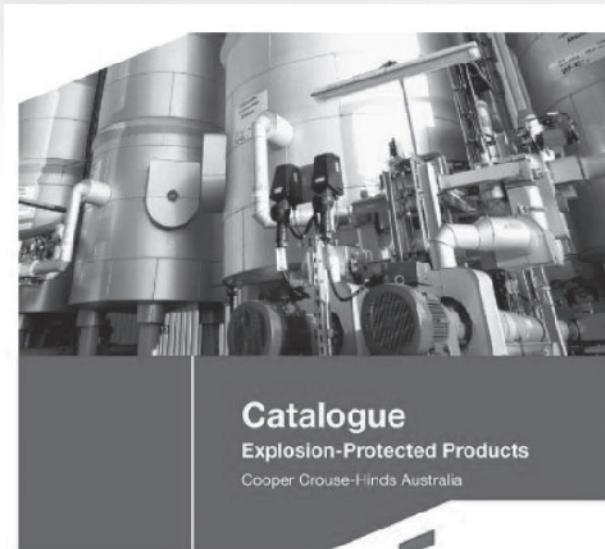

COOPER Crouse-Hinds



Explosion proof 'Bosston'
InstaMag



Raychem®

